

TOSHIBA

OWNER'S MANUAL

Color Television

COLORSTREAM™

27A50
32A50
36A50

Set up

Preparation

Basic Operation

Advanced Operation

Reference Section

Dear Customer

Congratulations! You have purchased one of the finest Color TV's on the market!

This manual will help you use the many exciting and useful features to make your TV viewing more enjoyable than ever before.

Before operating your TV set, please read all these safety and operating instructions completely and then retain for future reference.

Customer's Record

You will find the model number and serial number on the back of your TV set.

Record these numbers in the spaces provided below. Refer to them whenever you call upon your TOSHIBA dealer regarding this product.

Model Number _____

Serial Number _____

Safety Precautions

WARNING:

TO REDUCE THE RISK OF FIRE OR ELECTRIC SHOCK, DO NOT EXPOSE THIS APPLIANCE TO RAIN OR MOISTURE.

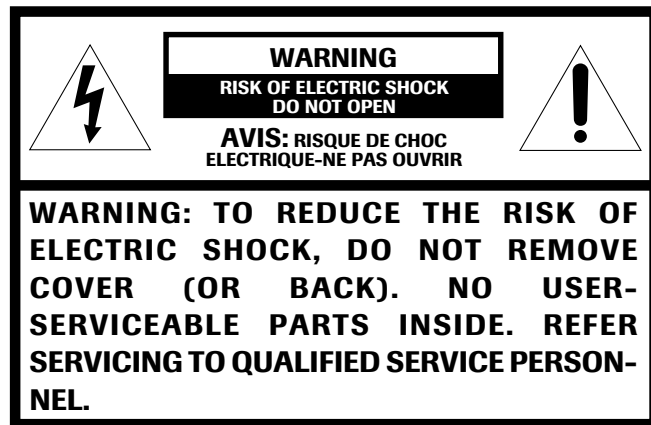

The lightning symbol in the triangle tells you that the voltage inside this product may be strong enough to cause an electric shock.

DO NOT TRY TO SERVICE THIS PRODUCT YOURSELF.



The exclamation point in the triangle tells you that important operating and maintenance instructions follow this symbol.

This TV set may be used only with TOSHIBA stand shown on page 35. Use with other stands may result in instability causing possible injury.

CAUTIONS:

TO PREVENT ELECTRIC SHOCK, DO NOT USE THIS POLARIZED PLUG WITH AN EXTENSION CORD RECEPTACLE OR OTHER OUTLET UNLESS THE PRONGS CAN BE FULLY INSERTED INTO THE OUTLET TO PREVENT ANY EXPOSURE OF THE PRONGS ON THE POLARIZED PLUG.

ATTENTION:

POUR PRÉVENIR LES CHOCS ÉLECTRIQUES, NE PAS UTILISER CETTE FICHE POLARISÉE AVEC UN PROLONGATEUR, UNE PRISE DE COURANT OU UNE AUTRE SORTIE DE COURANT, SAUF SI LES LAMES PEUVENT ÊTRE INSÉRÉS À FOND SANS EN LAISSER AUCUNE PARTIE À DÉCOUVERT.

Avoid displaying stationary images on your TV screen for extended periods of time. Stationary patterns generated by PIP display, computer displays, video games, stock market reports, etc. can become permanently engrained on the picture tube. This damage is not protected by your warranty as it is the result of misuse. Should you wish to use your TOSHIBA Television to display still images, it is always advisable to reduce brightness and contrast settings. Never leave a PIP display, a computer or video game display unattended.

Note to CATV system installer in the USA:

This reminder is provided to call the CATV system installer's attention to Article 820-40 of the NEC that provides guidelines for proper grounding and, in particular, specifies that the cable ground shall be connected to the grounding system of the building, as close to the point of cable entry as practical.

Table of Contents

Set Up

Introduction	4
Exploring your new TV	4
Installing Your TV	4
Connecting Your TV	5
Connecting a VCR	5
Connecting a cable converter box	5
Connecting a cable converter box and a VCR	6
Connecting a satellite receiver and a VCR	6
Connecting a DVD with component video and VCR	7
Connecting two VCRs	7

Preparation

Preparing the Remote Control for Use	8
Installing the Remote Control batteries	8
Location of Controls	9
Using the Remote with VCR or Cable TV Converter	10
Programming the Remote Control	11
Controlling other brands of VCR's and cable TV converters	11
Menu function (General Instructions)	14
First-Time Operation	15
Turning the TV set on	15
Selecting the on-screen display language	15
Programming Channel Memory	16
TV/CABLE function	16
CH PROGRAM function	16
ADD/ERASE function	17

Basic Operation

Watching TV Programs or Video Input	18
Selecting the TV channels	18
Selecting the video input source	18
Convenient Remote Functions	19
Displaying on-screen information	19
Muting the sound	19
Changing quickly between two channels	19
Adjusting the Picture	20
Adjusting the picture quality	20
Selecting the color temperature	21
Selecting the picture preference function	21
Adjusting the Sound	22
Adjusting the sound quality	22
Using the Off-Timer (Sleep Timer)	23
Setting the off-timer	23
Selecting Stereo/SAP Broadcasts	24
Listening to stereo sound	24
Activating the surround sound effect	24
Listening to second language	25

Advanced Operation

Watching Picture-in-Picture	26
Displaying a small picture	26
Using advanced functions	27
Programming Your Favorite Channels	28
Programming your favorite channels	28
Selecting your favorite channels	28
Operating Closed Caption Feature	29
Viewing captions or text	29
Using V-CHIP Control	30
Selecting the V-CHIP CONTROL menu	30
Adjusting the V-CHIP CONTROL menu	31
Unblocking programs temporarily	33
BLOCK CHANNEL function	33

Reference Section

Cleaning and Care	34
Specifications	35
Before Calling Service Personnel	36
Limited United States Warranty	37

Introduction

This manual applies to models 27A50, 32A50 and 36A50, and there are slight differences among them. The 32A50 is the model used for illustration purposes. Instructions in this manual are based on the Remote Control. Check the model of your TV before using this manual.

Exploring your new TV

You can operate your TV using the buttons on the front panel or the Remote Control. The back panel provides all the terminal connections you will need to connect other equipment to your TV.

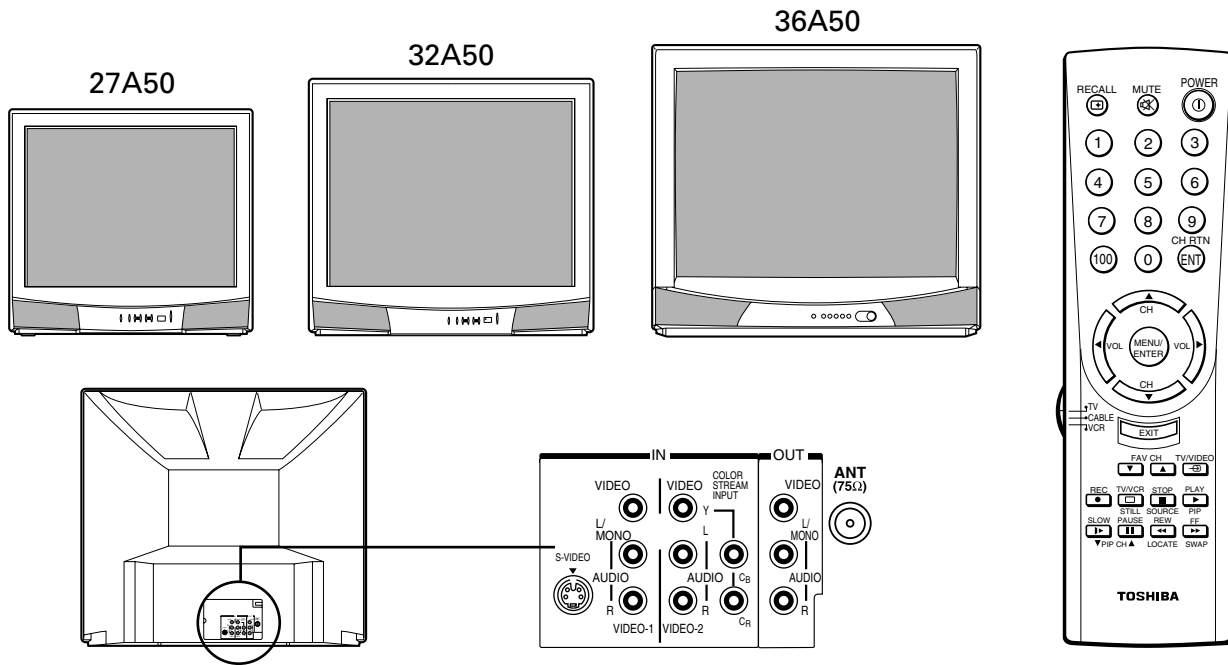

Selecting a location for the TV

- Place the TV on the floor or on a sturdy platform in a location where light does not directly hit the screen.
- Place the TV far enough from the walls to allow proper ventilation. Inadequate ventilation may cause overheating, which may damage the TV.

WARNING

To avoid personal injury:

- Do not stand or climb on the TV.
- Do not put a VCR or any heavy object on top of the TV.

Caution:

The plug has one prong wider than the other and will fit only one way into a standard electrical outlet (120 volt AC, 60 Hz). If the plug does not fit into the outlet, try turning it around. If the plug still does not fit, the outlet is probably non-standard and must be replaced by a qualified electrician. **Do not tamper with the plug or try to force it into a non-standard outlet.**

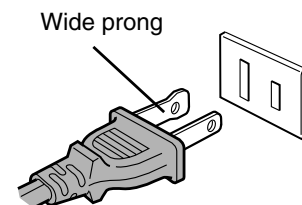

Connecting Your TV

If you haven't connected electronic equipment before, or you have been frustrated in the past, you may wish to read this section. (Cables are not supplied.)

- A coaxial cable is the standard cable that comes in from your antenna or cable converter box. Coaxial cables use "F" connectors.
- Audio and video cables are usually color coded according to use: yellow for video and red and white for audio. The red audio cable is for the stereo right channel, and the white audio cable is for the stereo (or mono) left channel. If you look at the rear panel of the TV, you will see that the terminals are color coded in the same manner as the cables.
- S-video cables provide better picture performance. S-video cables can only be used with S-video compatible components.
- ColorStream™ cables come in sets of three and provide the best picture performance. ColorStream cables can only be used with ColorStream compatible components.

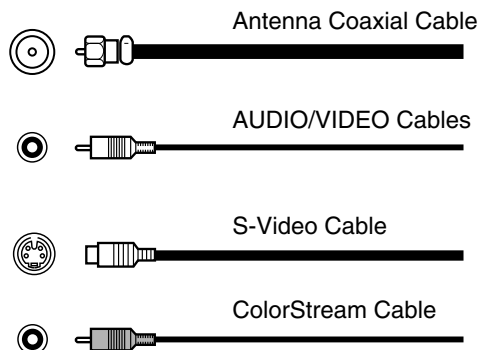

Caution:

Do not plug the TV in until you have finished connecting all of your equipment.

Connecting a VCR

This connection allows you to watch local channels and video programs, play or record on the VCR while watching TV, and to record from one channel while watching another channel.

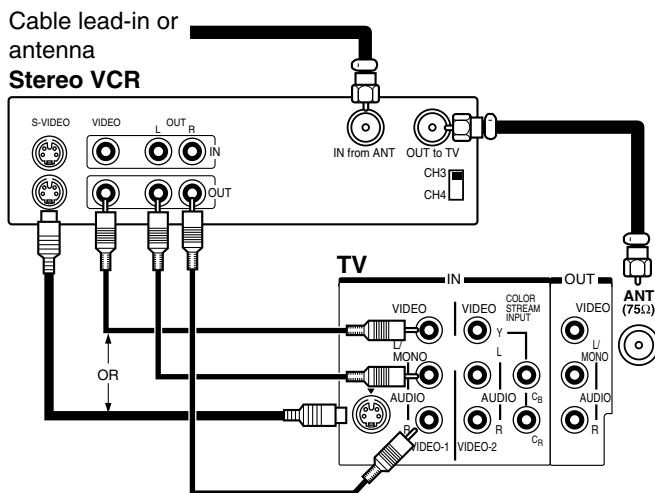

Caution:

If using a mono VCR, connect L/Mono to VCR Audio OUT using only one audio cable. If you have a S-VHS VCR, use the S-video connections and remove the video cable. Do not connect the video cable and the S-video cable to VIDEO 1 simultaneously.

Note:

The VIDEO 2 jacks can also be used for connecting a second piece of video equipment, such as a video disc player or camcorder etc. with audio/video outputs.

Connecting a cable converter box

This connection allows you to watch cable and premium channels. Tune the TV to channel 3 or 4 (whichever channel is vacant in your broadcast area), then use the converter box to change channels.

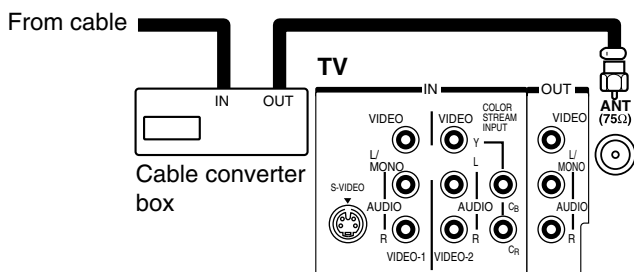

Note:

When you use a converter box with your TV, there may be features that you cannot program using the Remote Control, such as blocking channels, and programming your favorite channels.

Connecting Your TV (continued)

Connecting a cable converter box and a VCR

This connection allows you to watch and record basic and premium cable channels, as well as watch video tapes. Tune the TV and VCR channels to 3 or 4 (whichever channel is vacant in your area), then use the converter box to change channels.

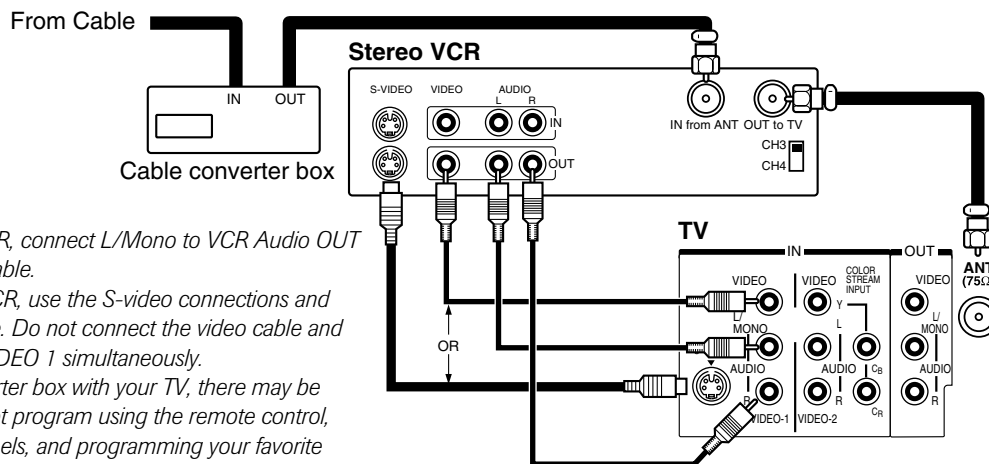

Caution:

- If you have a mono VCR, connect L/Mono to VCR Audio OUT using only one audio cable.
If you have a S-VHS VCR, use the S-video connections and remove the video cable. Do not connect the video cable and the S-video cable to VIDEO 1 simultaneously.
- When you use a converter box with your TV, there may be features that you cannot program using the remote control, such as blocking channels, and programming your favorite channels.

Connecting a satellite receiver and a VCR

This connection allows you to watch satellite, video and TV programs. You can record one TV channel while watching another channel.

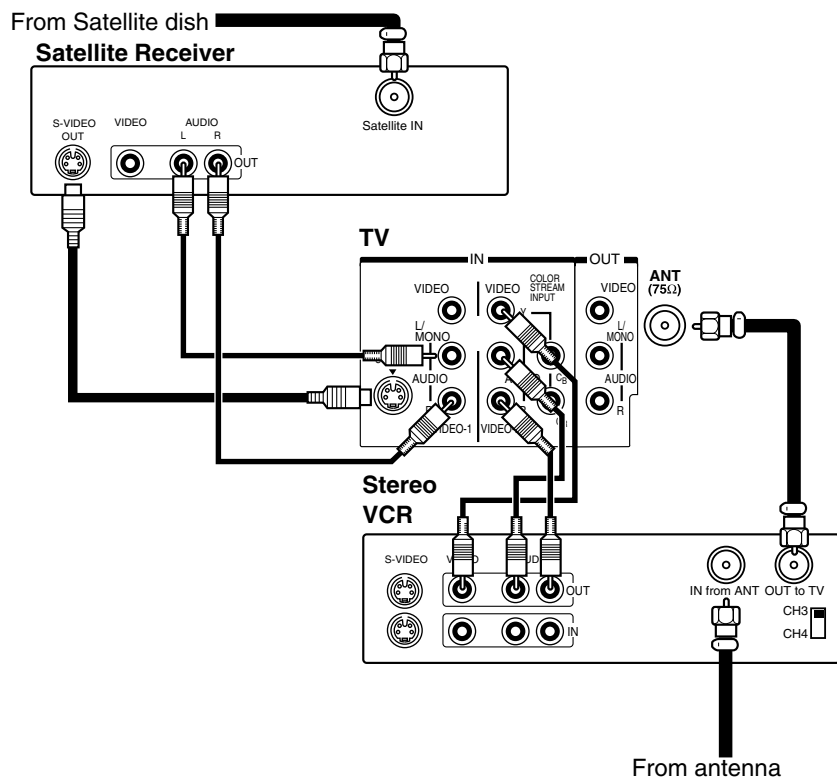

Caution:

- You can use a video cable instead of the S-video cable, but the picture quality will decrease.
Do not connect the video cable and the S-video cable to VIDEO 1 simultaneously.

Notes:

- To watch from the Satellite Receiver, the TV must select VIDEO 1.
- To watch from the VCR, the TV must select VIDEO 2.

Connecting a DVD with component video and VCR

This connection allows you to watch DVD, video or TV programs and to record TV programs. Your TV is capable of using ColorStream (component video). Connecting your TV to a ColorStream compatible DVD can greatly enhance picture quality and performance.

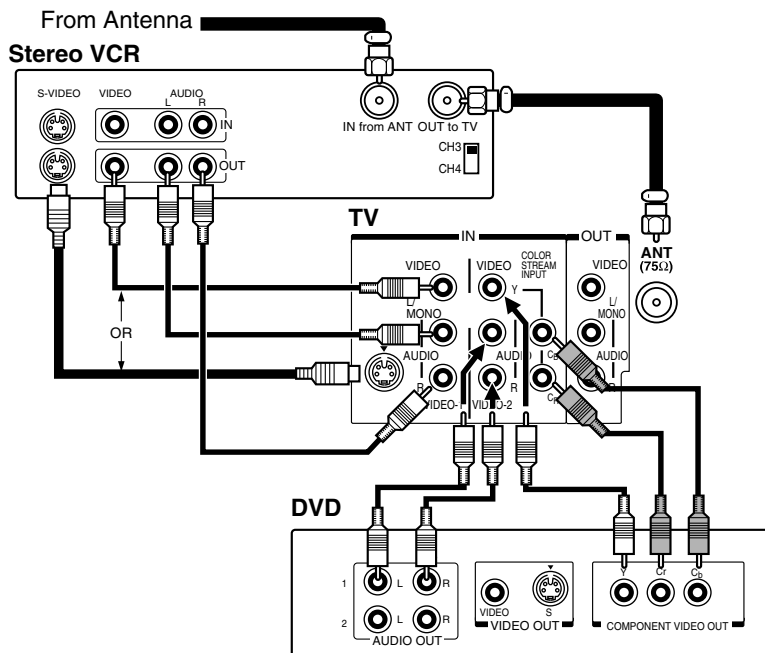

Caution:

The unauthorized recording of television programs, video tapes and other materials may infringe upon the provisions of copyright laws.

Notes:

- To watch from the VCR, the TV must select VIDEO 1.
- To watch from DVD, the TV must select VIDEO 2.

Connecting two VCRs

This connection allows you to record (dub/edit) from one VCR to another VCR while watching a video program. You will also be able to record from one TV channel while watching another channel.

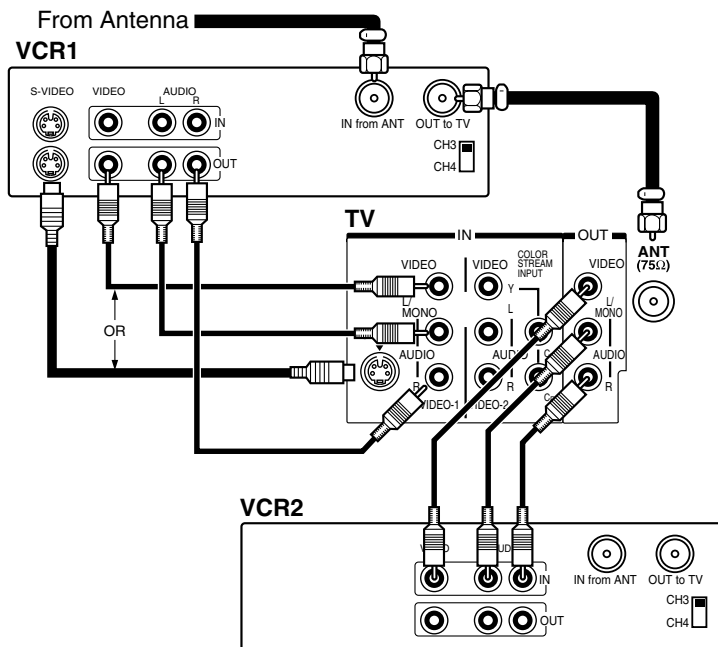

Caution:

The unauthorized recording of television programs, video tapes and other materials may infringe upon the provisions of copyright laws.

Note:

The TV must select Video 1 to dub or edit from VCR 1 to VCR 2. VCR 2 must select Line In when editing or dubbing from VCR 1.

Preparing the Remote Control for Use

With the Remote Control, you can operate your TV, most VCR models, and cable TV converters together, even if they are different brands. If you will be using your TV with a Toshiba VCR, your Remote Control is already programmed and ready to use. If you own different brands of VCR's and/or converters, you first have to program your Remote Control. (See "Programming the Remote Control" on page 11.)

Installing the Remote Control batteries

- 1 Slide the battery cover off of the back of the Remote Control.

Press and slide to remove.

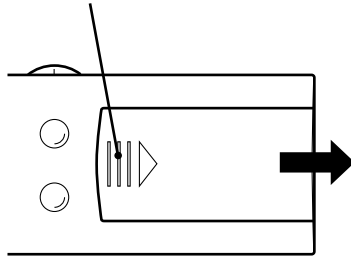

Caution:

- Dispose of your batteries in a designated disposal area. Do not throw your batteries into a fire.
- Do not mix battery types or combine used batteries with new ones.
- Remove dead batteries immediately to prevent battery acid from leaking into the battery compartment.
- If you do not intend to use the remote control for a long time, remove the batteries.

- 2 Install two "AA" size batteries. Match the + and – signs on the batteries to the signs on the battery compartment.

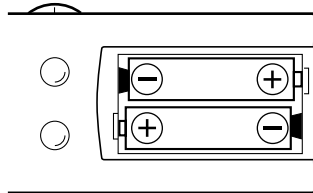

Note:

This Remote Control's functions may or may not operate your VCR or cable TV converter. Refer to the owner's manuals supplied with the equipment to see which features are available. In addition, the original controllers may have features not available on this Remote Control. If you would like to continue to use these features, you may want to use the original remote control.

- 3 Slide the battery cover back on to the Remote Control until the lock snaps.

Location of Controls

For details on the use of each control, refer to pages in brackets.

TV front panel

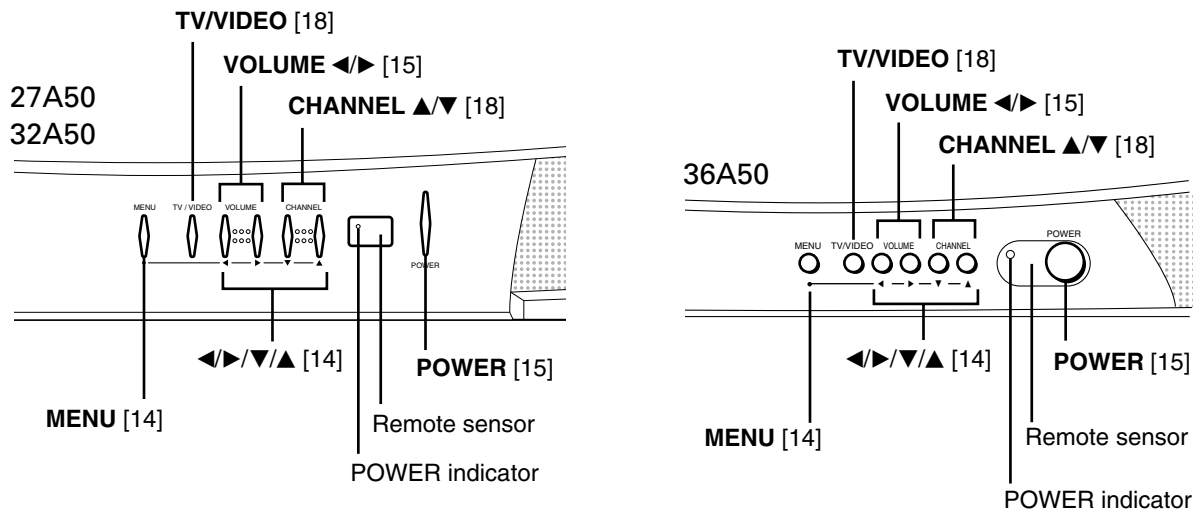

Remote Control

- This Remote Control is equipped with the buttons (marked ●) that glow (discharge) in the dark.
- Only the buttons that are used to operate the TV set are described here.

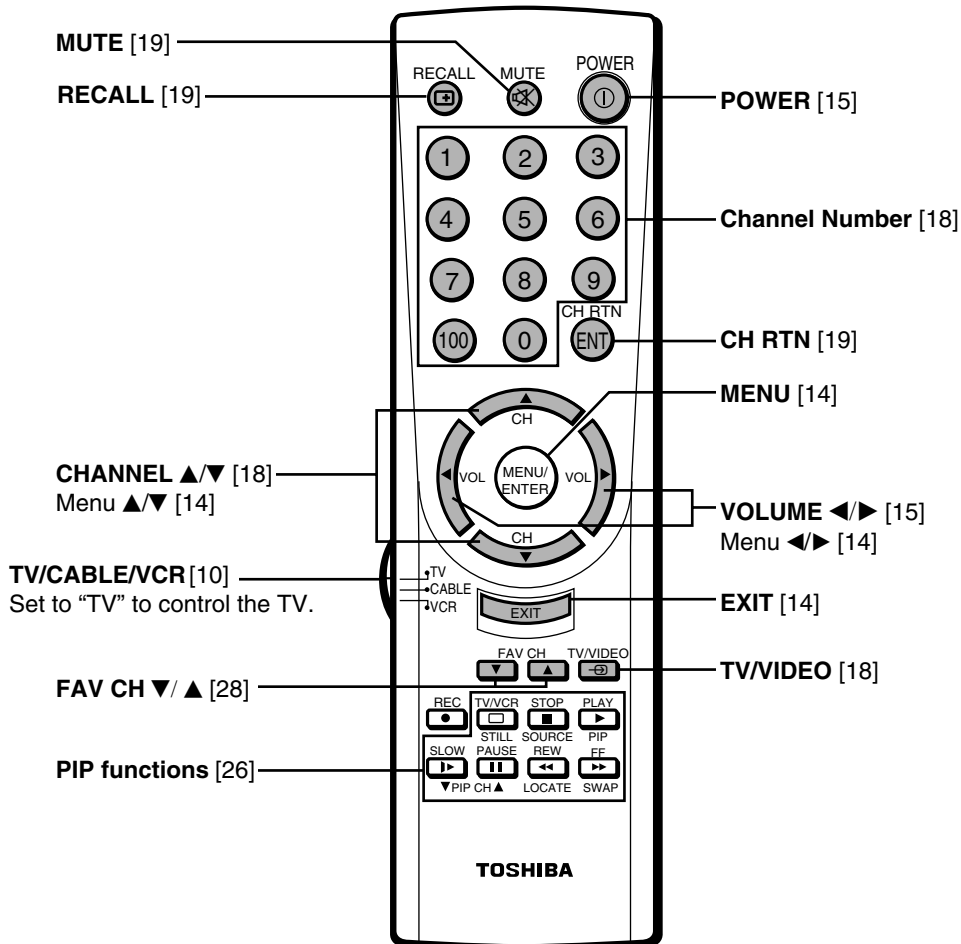

Using the Remote with VCR or Cable TV Converter

- To control a TOSHIBA VCR, first set the **TV/CABLE/VCR** switch to “VCR” position. The buttons shown below will then control the VCR. The rest of the buttons operate the TV as usual. If you have another brand of VCR, you can probably program your Remote to control it. Details are on page 11.
- To control a cable TV converter, this Remote Control must be programmed to recognize the brand of your converter. See page 11. The shaded buttons can be used to control the cable TV converter. Set the **TV/CABLE/VCR** switch to “CABLE” position whenever you control the cable TV converter.

Aim at the VCR or cable TV converter

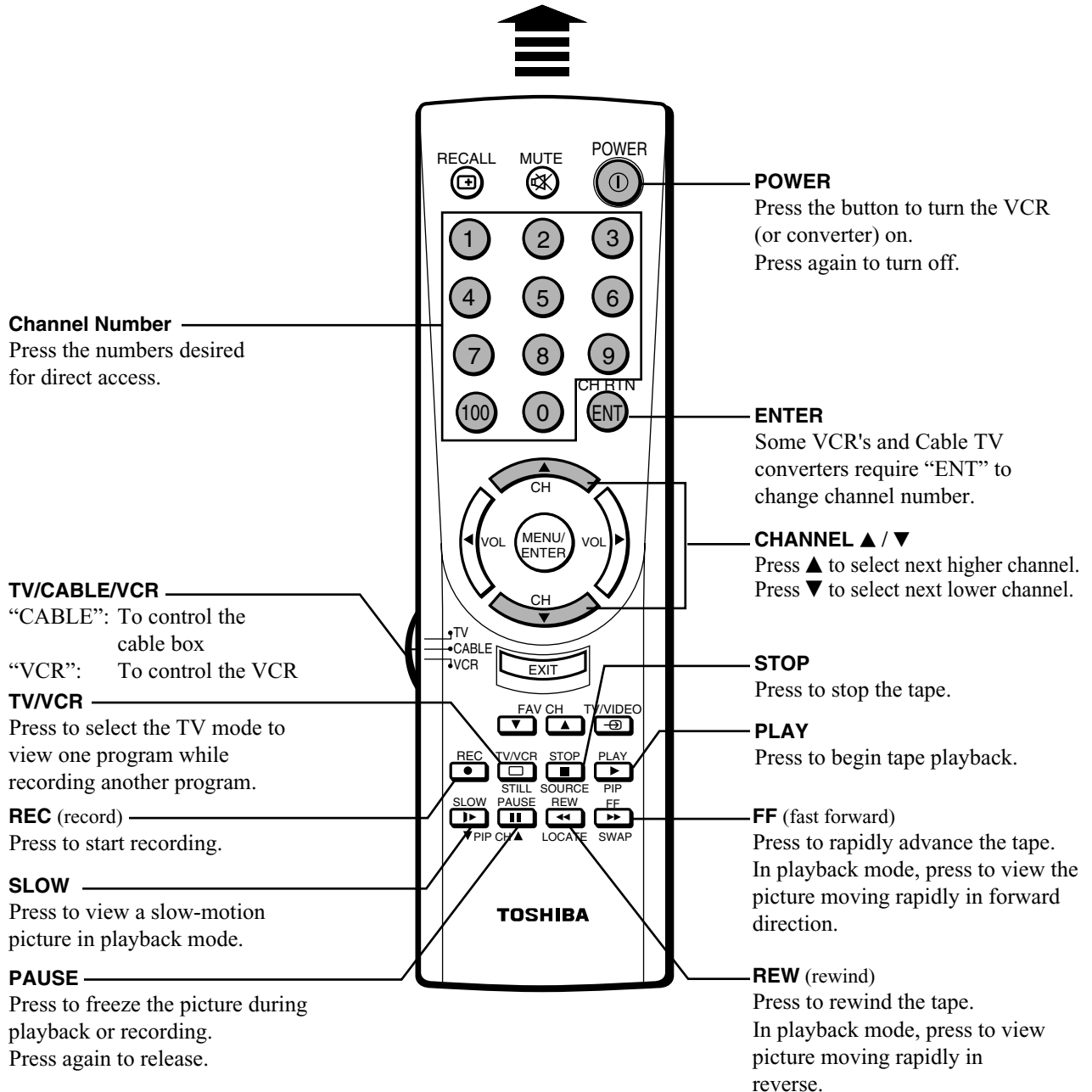

Programming the Remote Control

- This Remote Control is preprogrammed to operate TOSHIBA VCR's.
- To use VCR's other than TOSHIBA models (or cable converter), perform the following procedures before operating.

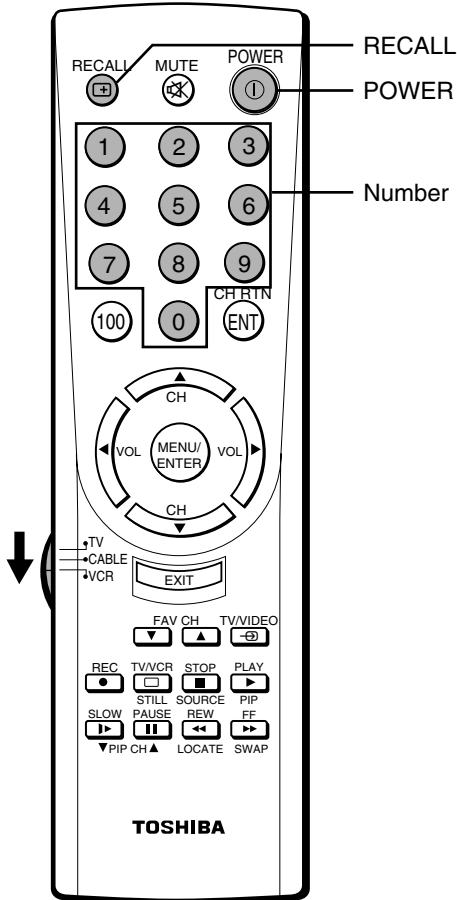

Controlling other brands of VCR's and cable TV converters

- 1 Refer to the “**VCR code table**” (or “**Cable TV converter code table**”) on pages 12 and 13 to find the code number that corresponds to the brand name of your VCR (or converter).

If more than one number is listed, try each one separately until you find the one that works.

- 2 Set the **TV/CABLE/VCR** switch to “VCR” (or “CABLE”).
- 3 Hold down **RECALL** while pressing the **Number** buttons for the three digit code number for your brand of VCR (or converter).
- 4 Point the Remote Control at the VCR (or at the converter) and press **POWER** to test the code number.
 - If the right number was entered, the VCR (or the converter) should turn off.
 - If the VCR (or the converter) does not respond to the Remote Control, repeat steps 1 to 4 with another code number.

For future reference, write down the code numbers you used:

VCR CODE _____

CABLE CODE _____

Notes:

- You have to reprogram the Remote Control when you change its batteries.
- Some newer VCR's are capable of working on either of two remote codes. These VCR's have a switch labeled “VCR1/VCR2”.

If your VCR has this kind of switch, and does not respond to all the code numbers for your VCR brand name, set the switch to another position (“VCR1” or “VCR2”) and reprogram the Remote Control.

Programming the Remote Control (Continued)

- In some rare cases, you may not be able to operate your non-Toshiba equipment with the supplied Remote Control. This is because your equipment may use a code that is not provided with this Remote Control. In this case, please use the equipment's own remote control.

VCR code table

BRAND NAME	CODE NUMBER	BRAND NAME	CODE NUMBER	BRAND NAME	CODE NUMBER
Adventura	019	Jensen	060	Radio Shack	019,056,344
Aiko	297	JVC	027,060,086	Radix	056
Aiwa	019	Kenwood	057,060,086	Randex	056
Akai	060,068,080,125, 261	KLH	091	RCA	061,079,084,096, 124,125,168,221
American High	054	Kodak	054,056	Realistic	019,054,056,065, 066,067,081,085, 123,259
Asha	259	Lloyd	019	Ricoh	053
Audiovox	056	Lloyd's	227	Runco	058
Beaumarck	259	Logik	091	Samsung	064,259
Bell & Howell	123	LXI	056	Sanky	058,067
Bond	206	Magnavox	054,058,100,129,168	Sansui	060,086
Broksonic	140,203,230,314, 380	Magnin	259	Sanyo	065,066,123,259
Calix	056	Marantz	054,100	Scott	062,064,140,203, 229,230,231
Canon	054	Marta	056	Sears	054,056,061,065, 066,073,085,123, 124
Capehart	039	Matsushita	054	Sharp	067,081
Carver	100	MEI	054	Shintom	091
CCE	091,297	Memorex	019,054,056,058, 065,066,067,123, 259	Shogun	259
Citizen	056,297	MGA	062,080	Singer	091
Colt	091	MGN Technology ...	259	Sony	051,052,053,054
Craig	056,066,091,259	Minolta	061,124	STS	061
Curtis Mathes	054,060,079	Mitsubishi	062,080,086,094	Sylvania	019,054,062,100, 129
Cybernex	259	Motorola	054,067	Symphonic	019,344
Daewoo	039,064,297	MTC	019,259	Tatung	060
Daytron	039	Multitech	019,091	Teac	019,060
Dynatech	019	NAD	077	Technics	054,181
Electrohome	056	NEC	057,059,060,069,086	Teknika	019,054,056,071
Electroponic	056	Nikko	056	Telefunken	206
Emerex	051	Noblex	259	TMK	227,259
Emerson	019,021,056,062, 080,087,140,203, 227,228,230,231, 297,313,314,380, 498	Olympus	054	Toshiba	062,064,085,229, 231,385
Fisher	066,073,085,123	Optimus	056,067,077,123	Totevision	056,259
Fuji	052,054	Optonica	081	Unitech	259
Funai	019,344	Orion	498	Vector	064
Garrard	019,344	Panasonic	054,096,181,244,473	Vector Research	057,059
GE	054,079,084,221	Penney	054,056,057,059, 061,073,259	Video Concepts	059,064,080
Goldstar	037,056,057	Pentax	061,084,124	Videosonic	259
Gradiente	019	Philco	054	Wards	019,054,061,066, 067,081,091,168, 231,259
Harley Davidson	019	Philips	054,081,100,129	XR-1000	019,054,091
Harman/Kardon	057,094	Pilot	056	Yamaha	057
Harwood	087,091	Pioneer	077,086	Zenith	052,053,058
Headquarter	065	Portland	039		
HI-Q	066	Protex	091		
Hitachi	060,061,084,124, 185, 254	Pulsar	058		
		Quarter	065		
		Quarts	065		
		Quasar	054,096		

Cable TV converter code table

BRAND NAME	CODE NUMBER	BRAND NAME	CODE NUMBER
ABC	020,022,026,027, 030,032,033,036, 066	Regency	021
Antronix	041	Rembrandt	030,089
Archer	041,058,172	Runco	019
Belcor	075	Samsung	059,163
Cable Star	075	Scientific Atlanta	025,027,036,296
Cabletenna	041	Signal	034,059
Cableview	041	Signature	030
Century	172	SL Marx	059
Citizen	172	Sprucer	040
Colour Voice	044,050	Standard Components	174
Comtronics	059,079	Starcom	022,034,066
Contec	038	Stargate	034,059
Dae Ryung	027	Starquest	034
Eastern	021	Sylvania	020
Focus	419	Televue	059
Garrard	172	Texscan	020
GC Electronics	075	Tocom	031,032,078
Gemini	034,089	Toshiba	019
General Instrument	030,295	Tusa	034
Goldstar	059,163	Unika	041,172
Hamlin	028,039,053,278, 292	United Artists	026
Hitachi	030	United Cable	022
Hytex	026	Universal	041,058,075,172
Jasco	172	Viewstar	046,079,230
Jerrold	022,030,031,033 034,066,295	Zenith	019
Macom	052	Zentek	419
Magnavox	046		
Memorex	019		
Movie Time	175		
NSC	089,175		
Oak	026,038,267		
Panasonic	019,040,126		
Paragon	019		
Philips	044,046,047,048 049,050,172		
Pioneer	042,163,552		
Popular Mechanics	419		
Pulsar	019		
RCA	040		
Recoton	419		
Regal	039,278,292		

Menu Function (General Instructions)

We suggest you familiarize yourself with this procedure before using the Menu function. To adjust any TV feature, the use of the Menu function is required. The adjustments that can be made to the TV appear on the screen.

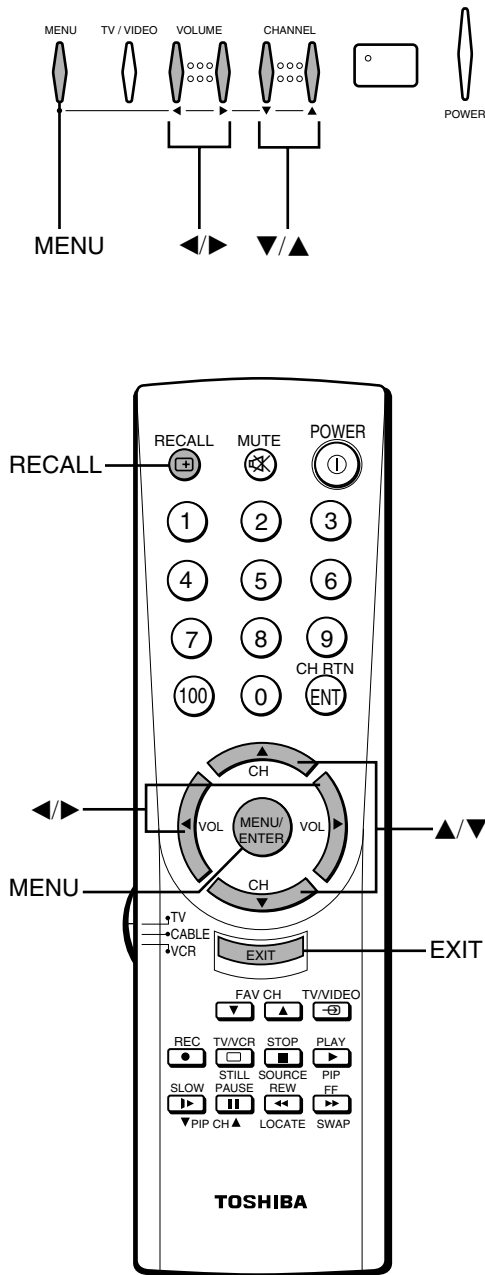

MENU button (on TV and on Remote)

Each time you press **MENU**, the Picture, Audio, Setup or Option menu on-screen display is selected in order, then press **▼** or **▲**.

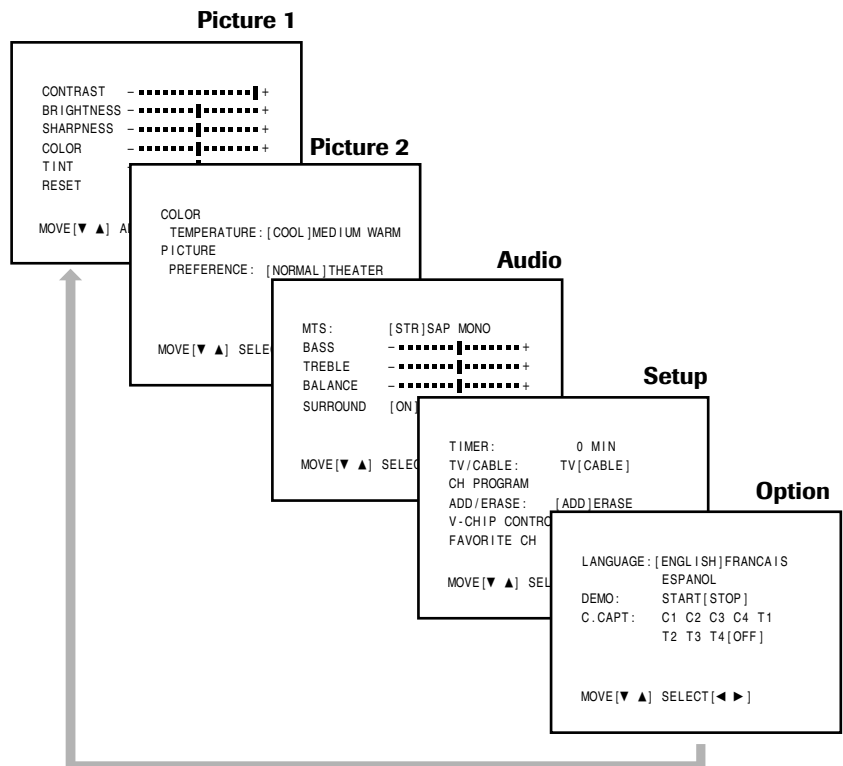

▼/▲ buttons (on TV and on Remote)

Use **▼** or **▲** after you have selected the on-screen menu you want to adjust with the **MENU** button.

Each time you press **▼** or **▲**, the function to be adjusted will be selected in order.

▼ button from top to bottom

▲ button from bottom to top

The selected function will be displayed in purple.

◀▶ buttons (on TV and on Remote)

Use **◀** or **▶** to adjust the function you have selected with the **▼/▲** buttons.

EXIT button (on Remote)

The above four menu displays will automatically disappear from the screen if no control has been operated for about 15 seconds.

If you want to clear the screen of all on-screen menus instantly, press **EXIT**.

Notes:

- The **◀▶** buttons will function as the **VOLUME** **◀▶** buttons when no menu display is on the screen.
- The **▲▼** buttons will function as the **CHANNEL** **▲▼** buttons when no menu display is on the screen.

First-Time Operation

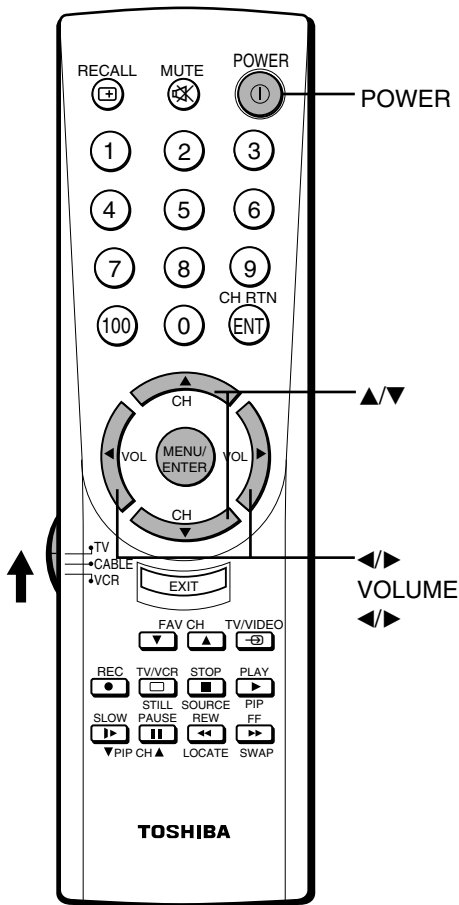
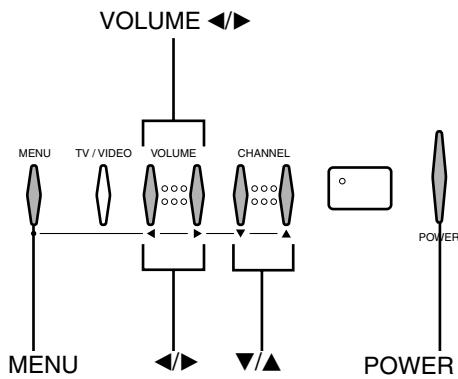

Turning the TV set on

1 Set the **TV/CABLE/VCR** switch on the Remote Control to “TV” position.

2 Press **POWER** to turn on the TV.

To turn off the TV, press **POWER** again.



3 Press **VOLUME** ◀▶ to adjust the volume.

To increase the volume, press ▶.

To decrease the volume, press ◀.

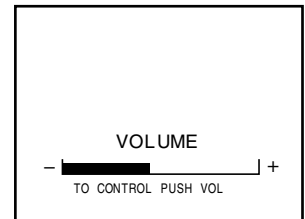

Selecting the on-screen display language

1 Press **MENU** until the Option menu is displayed on the screen.

2 Press ▲ or ▼ repeatedly until “LANGUAGE” is displayed in purple.

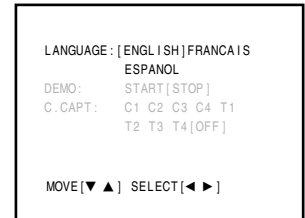

3 Press ◀ or ▶ until your desired language is displayed in purple.
If you select “FRANCAIS” for example, the display language changes to French.

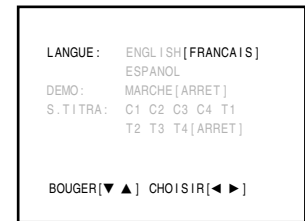

Understanding Auto-Power-Off feature

If a vacant channel is tuned or TV broadcast for a day is finished, the TV will automatically turn off after about 15 minutes.

This feature does not operate in the VIDEO mode.

Understanding Last Mode Memory feature

If the power is cut off while you are viewing the TV and the power is resupplied, the TV is turned on automatically by the **Last Mode Memory** feature. If the power is going to be off or when you leave home for a long time, remove the power plug from the wall outlet to prevent the TV from turning on in your absence.

Programming Channel Memory

The channel memory is the list of TV channel numbers your TV will stop on when you press the **CHANNEL ▲** or **▼** button. **First, use the TV/CABLE and CH PROGRAM functions to preset all active channels in your area.** If necessary, arrange the preset channels with the ADD/ERASE functions so that you can tune into only desired channels.

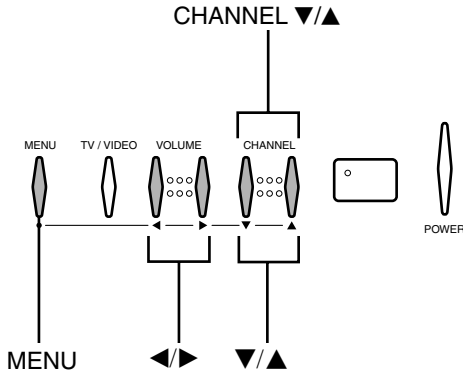

TV/CABLE function

- 1 Press **MENU** until the Setup menu is displayed on the screen.
- 2 Press **▲** or **▼** until “TV/CABLE” is displayed in purple.
- 3 Press **◀** or **▶** until the mode that corresponds to your TV signal system is displayed in purple.
 - TV:** TV broadcast signals.
(VHF channels 2 through 13 and UHF channels 14 through 69)
 - CABLE:** Cable TV signals.
(Cable channels 1 through 125)

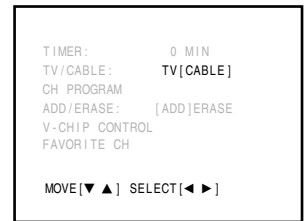
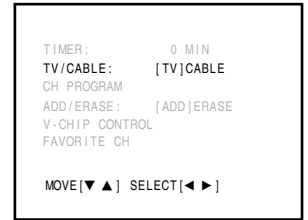

CH PROGRAM function

- 1 Press **MENU** until the Setup menu is displayed on the screen.
- 2 Press **▲** or **▼** repeatedly until “CH PROGRAM” is displayed in purple.
- 3 Press **◀** or **▶** to start channel programming. The TV will automatically cycle through all the TV or CABLE channels depending on the mode selected, and store active channels in the channel memory.
- 4 When channel programming is complete, you will see the message at the right.

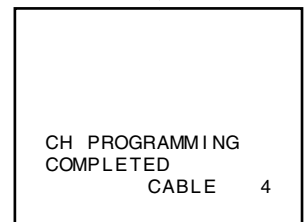
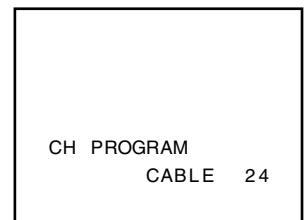
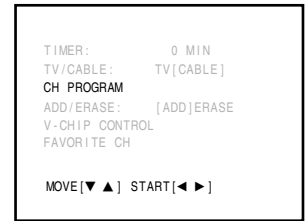

- 5 Press **CHANNEL ▲** or **▼** to make sure the channel programming has been done properly.

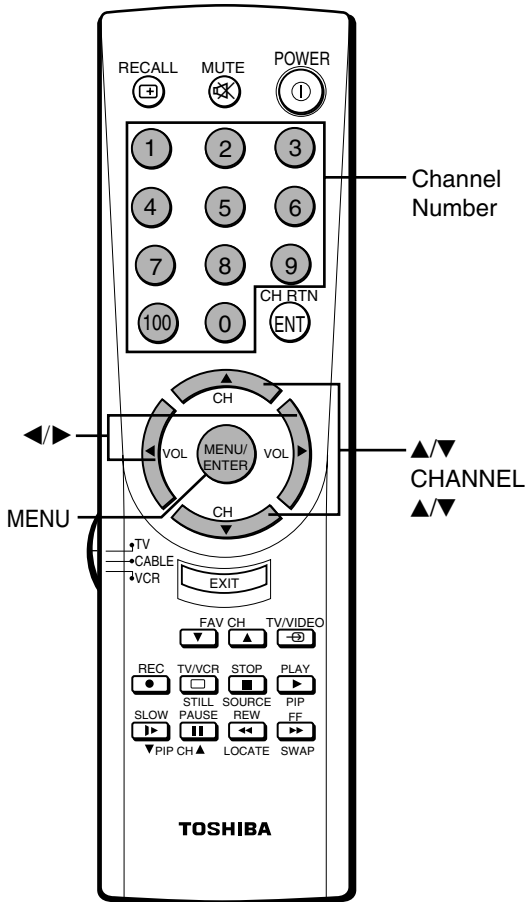

ADD/ERASE function

After performing the CH PROGRAM function, you can add or erase specific channels.

- 1 Select the channel you want to erase using the **CHANNEL ▲** or **▼** button, or select the channel you want to add using the **Channel Number** buttons.

- 2 Press **MENU** repeatedly until the Setup menu is displayed on the screen.

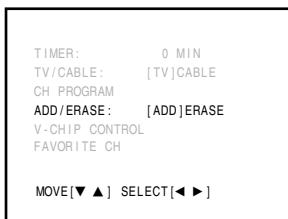

- 3 Press **▲** or **▼** repeatedly until “ADD/ERASE” is displayed in purple.

- 4 Press **◀** or **▶** :

To erase the channel

Press the button until “ERASE” is displayed in purple indicating that the channel has been erased from the memory.

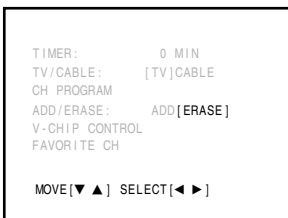

To add the channel

Press the button until “ADD” is displayed in purple indicating that the channel has been memorized.

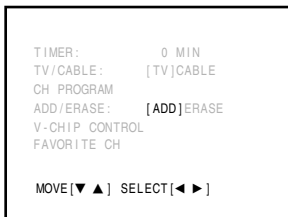

- 5 Repeat steps 1 to 4 for other channels.

You have now completed the channel programming.

CABLE channel reference chart

Number on this TV	Corresponding CABLE channel	Number on this TV	Corresponding CABLE channel
1	A-8	67	67
5	5(A-7)	68	68
6	6(A-6)	69	69
14	A	92	92
15	B	93	93
16	C	94	94
34	U	95	A-5
35	V	96	A-4
36	W	97	A-3
37	AA	98	A-2
38	BB	99	A-1
60	XX	100	100
61	YY	101	101
62	ZZ	102	102
63	AAA	123	123
64	BBB	124	124
65	65	125	125
66	66		

The above chart is typical of many cable system channel allocations. If in doubt, consult your cable company.

Watching TV Programs or Video input

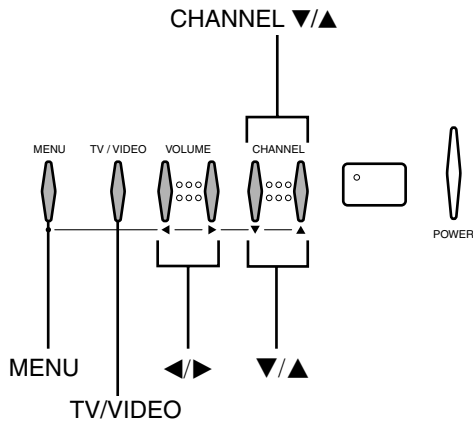

Selecting the TV channels

Select a channel in one of the following two ways.

- **To scan the memorized channels in numerical sequence**

Press **CHANNEL ▲** to select the next higher channel.

Press **CHANNEL ▼** to select the next lower channel.

Press the button again to select the next memorized channels.

- **To select a channel directly**

Press the **Channel Number** buttons (0-9 and 100).

To select channel 4, press “4” (or press “0”, “4”).

To select channel 38, press “3”, “8”.

To select channel 125, press “100”, “2”, “5” in sequence.

If you cannot select certain channels, either TV (off the air) or CABLE channels

Check if the TV/CABLE function is properly set. See page 16.

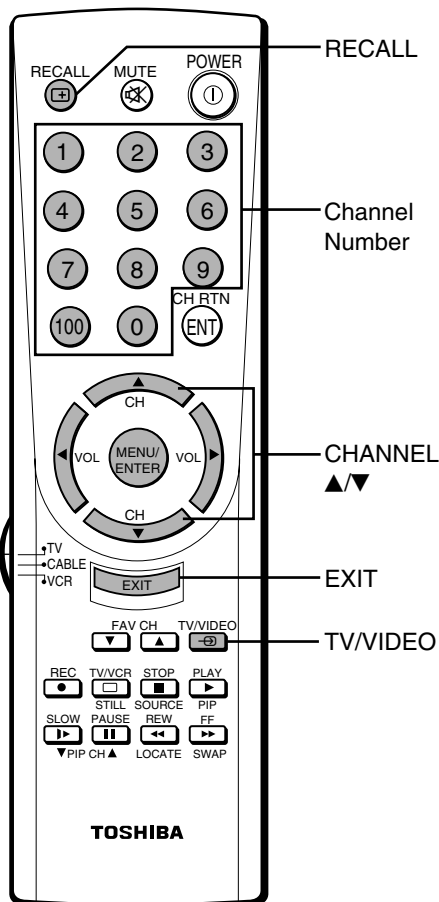

Selecting the video input source

You can use the **TV/VIDEO** button to view signal coming from other devices, such as VCR's or video disc players that may be connected to your TV. (See “Connecting Your TV” on page 5.)

Note: To operate your TV and video equipment properly, refer to the instructions furnished with the video equipment.

- 1 Turn the TV and the video equipment ON.
- 2 Press **TV/VIDEO** on the Remote Control or on the TV to select “VIDEO 1” or “VIDEO 2”.

The selected source will be displayed in purple.



- 3 Operate the video equipment normally.

About the Demonstration Mode

When this function is activated, your TV will automatically display a variety of its on-screen menus and special features. This function is provided for demonstration purposes only.

- 1 Press **MENU**, then **▲** or **▼** until “DEMO” in the Option menu is displayed in purple.
- 2 Press **◀** or **▶** to select “START”.

The on-screen demonstration will start after about 15 seconds.



To stop the demonstration

Press **EXIT** or **RECALL** on the Remote or select “STOP” in the menu.

Convenient Remote Functions

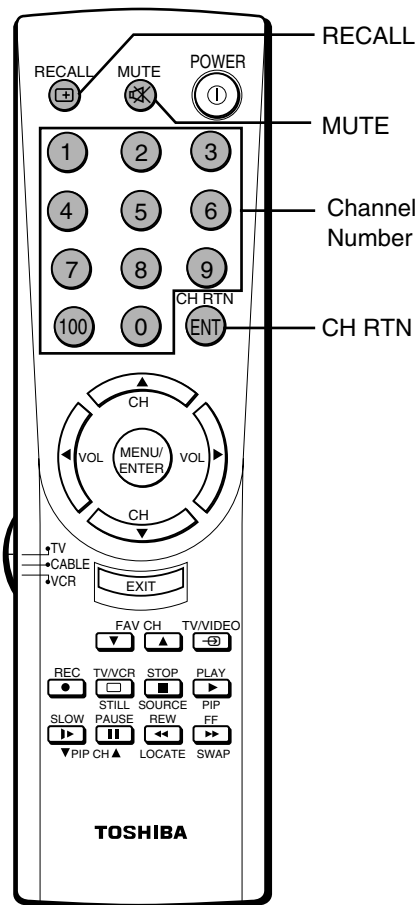

Displaying on-screen information

Press **RECALL** to display the following on-screen information.

- Channel number or VIDEO mode selected
- Stereo or SAP audio status
- V-CHIP rating

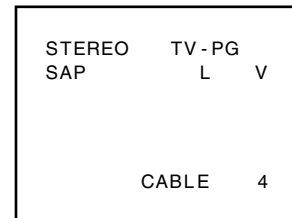

Muting the sound

Press **MUTE** to mute the sound. The word "MUTE" will be displayed on the screen as shown. This is useful during telephone calls or other interruptions.

To restore the sound, press **MUTE** again.

*Note: When the **MUTE** button is pressed, the Closed-Captioned feature "C1" is activated. ("MUTE" on the screen display will disappear.) To deactivate, press the **MUTE** button again. (This feature only functions when the Closed Caption mode is set to "OFF".)*

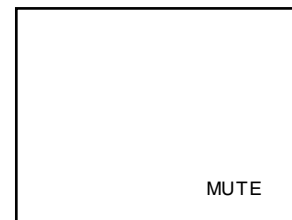

Changing quickly between two channels

Press **CH RTN** to return to the last channel viewed.

This is useful should you want to view two channels. This allows you to view two programs without entering an actual channel number each time.

To operate this function

- 1 Select the first channel you want to view.
- 2 Select the other channel with the **Channel Number** buttons.
- 3 Press **CH RTN**.
The previous channel will return.

Each time you press **CH RTN**, the TV will switch back and forth between the two channels.

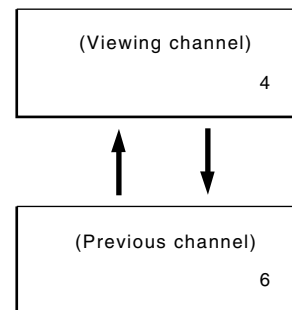

Adjusting the Picture

You can adjust the picture quality (CONTRAST, BRIGHTNESS, SHARPNESS, COLOR and TINT) to suit your taste.

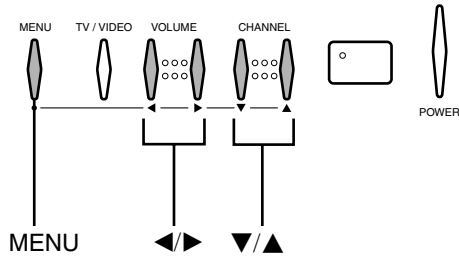

Adjusting the picture quality

- 1 Press **MENU** repeatedly until the Picture 1 menu is displayed on the screen.
- 2 Press **▲** or **▼** until the item you want to adjust is displayed in purple.

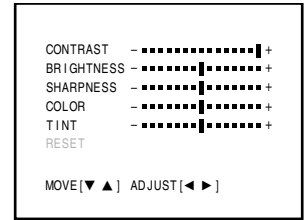

- 3 Press **◀** or **▶** to adjust the level.

Example: CONTRAST adjustment mode display

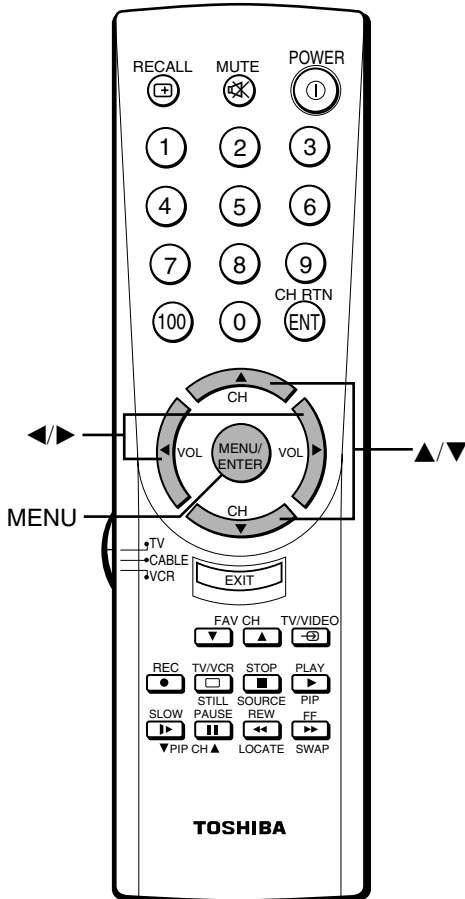
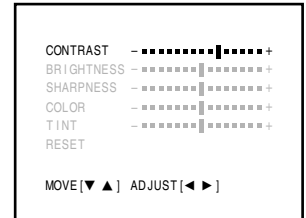

Selection	Pressing	
	◀	▶
CONTRAST	lower	higher
BRIGHTNESS	darker	lighter
SHARPNESS	softer	sharper
COLOR	paler	deeper
TINT	reddish	greenish

To reset the Picture and Sound adjustments to the factory-preset status (maximum CONTRAST and all other adjustments centered)

- 1 Press **MENU** until the Picture 1 menu is displayed on the screen.
- 2 Press **▲** or **▼** until “RESET” is displayed in purple.
- 3 Press **◀** or **▶**.

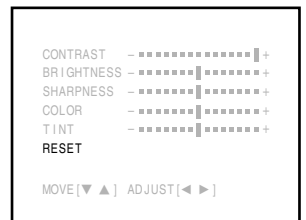

Selecting the color temperature

These selections change the appearance of gray and white tones of the picture.

- 1 Press **MENU** repeatedly until the Picture 2 menu is displayed on the screen.
- 2 Press **▼** or **▲** until “COLOR TEMPERATURE” is displayed in purple.

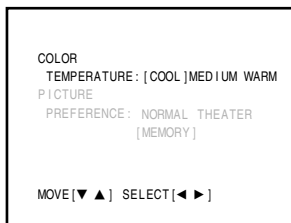

- 3 Press **◀** or **▶** until the mode you want is displayed in purple.

Mode	Picture quality
COOL	Bluish
MEDIUM	Neutral
WARM	Reddish

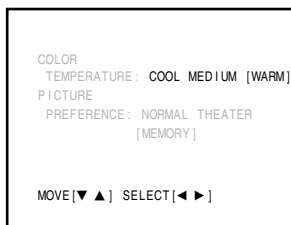

Note:

The **RESET** function adjusts the following picture and audio functions.

- **CONTRAST** Max.
- **BRIGHTNESS** Center
- **COLOR** Center
- **TINT** Center
- **SHARPNESS** Center
- **COLOR TEMPERATURE** COOL
- **PICTURE PREFERENCE** NORMAL
- **BASS** Center
- **TREBLE** Center
- **BALANCE** Center

Selecting the picture preference function

You can select a desired picture tone from three picture preset modes (NORMAL, THEATER, MEMORY) instantly.

- 1 Select “PICTURE PREFERENCE” following the steps 1 and 2 above.

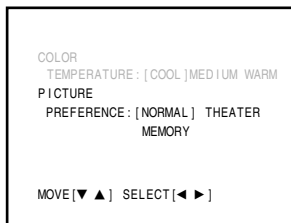

- 2 Press **◀** or **▶** until the mode you want is displayed in purple.

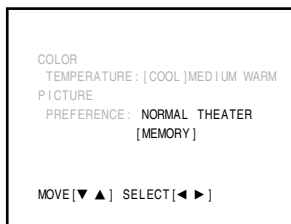

Mode	Picture quality
NORMAL	The picture quality preset at the factory
THEATER	Movie-like picture setting
MEMORY	The picture quality you set (First follow page 20.)

Adjusting the Sound

You can adjust the sound quality (BASS, TREBLE and BALANCE) to suit your taste.

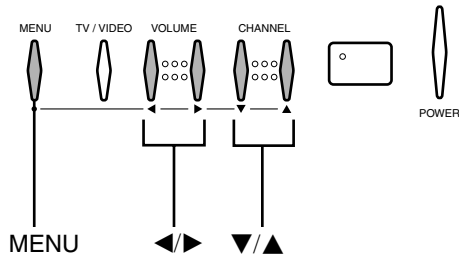

Adjusting the sound quality

- 1 Press **MENU** until the Audio menu is displayed on the screen.
- 2 Press **▲** or **▼** until the item you want to adjust is displayed in purple.

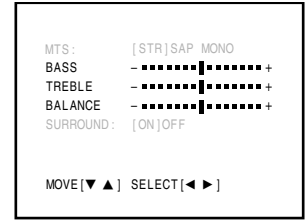

- 3 Press **◀** or **▶** to adjust the level.

Example: BASS adjustment mode display

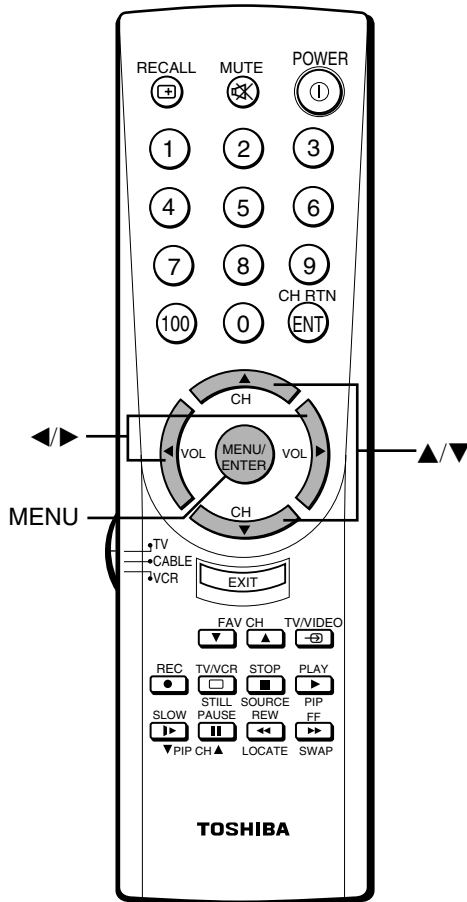
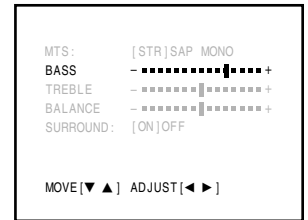

Selection	Pressing	
	◀	▶
BASS	weaker	stronger
TREBLE	weaker	stronger
BALANCE	decreases the right channel	decreases the left channel

Using the Off-Timer (Sleep Timer)

With the off-timer, you can set the TV to turn off automatically after a pre-determined period of time (up to 3 hours, in 10 minutes increments).

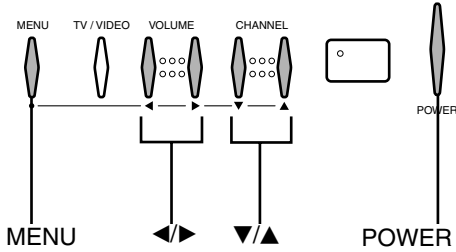

Setting the off-timer

1 Press **MENU** until the Setup menu is displayed on the screen.

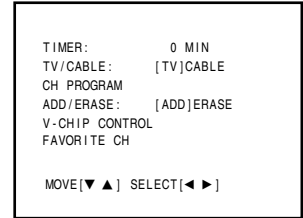

2 Press **▲** or **▼** until "TIMER" is displayed in purple.

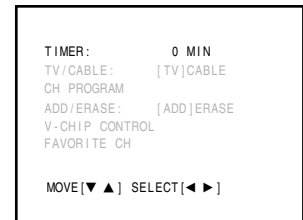

3 Press **◀** or **▶** to enter the length of time you want the TV to stay on. Each time you press the button, the time display will increase (▶) or decrease (◀) by 10 minutes.

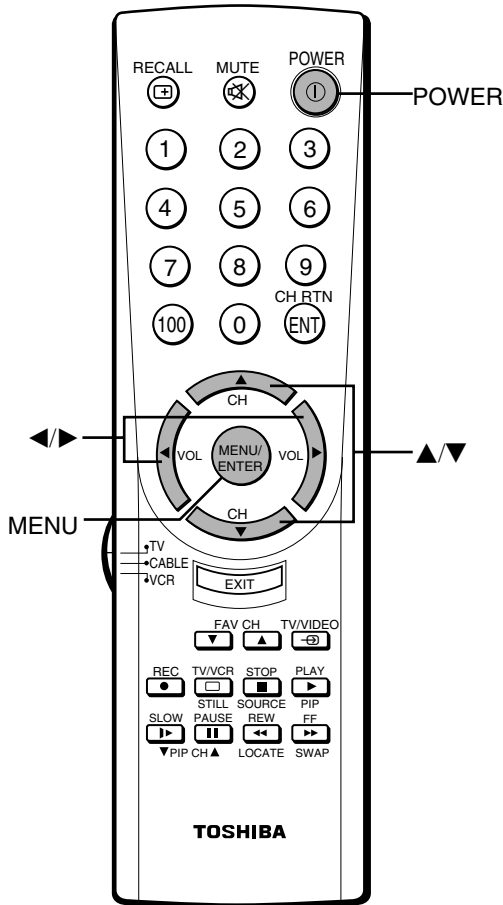
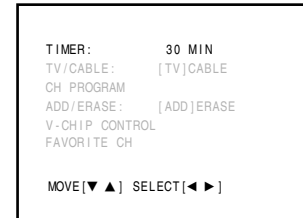

To cancel the setting

Press **POWER** twice, once to turn the TV off and once to turn it on again.

Selecting Stereo/SAP Broadcasts

The MTS (Multi-channel TV Sound) feature allows you to improve your TV viewing with high fidelity stereo sound. This TV also allows you to activate or deactivate the stereo surround sound effect.

MTS also provides for an extra channel, SAP (Second Audio Program), used to transmit a second language or other audio information.

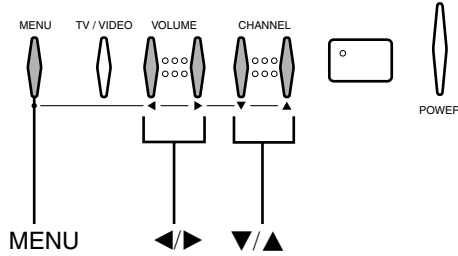

Listening to stereo sound

1 When the TV receives a stereo broadcast, the word “STEREO” is displayed on the screen whenever the TV is turned on, a channel is selected, or the **RECALL** button is pressed.

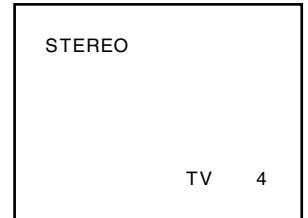

2 Press **MENU** until the Audio menu is displayed on the screen.

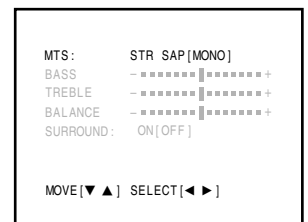

3 Press **▲** or **▼** until “MTS” is displayed in purple.

If a stereo broadcast is received, “STR” will be displayed in yellow.

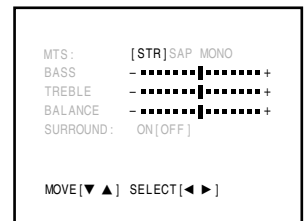

4 Press **◀** or **▶** until “STR” (stereo) is displayed in purple.

You should leave your TV on “STR” so you can automatically receive stereo or monaural sound, depending on the broadcast type. If the stereo sound is noisy, select “MONO” to reduce the noise.

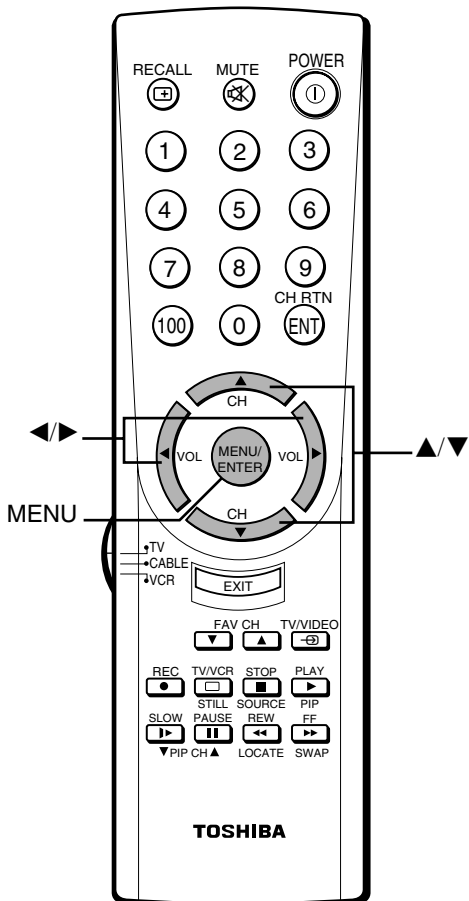

Activating the surround sound effect

1 Select the Stereo mode as described above.

2 Press **MENU** until the Audio menu is displayed on the screen.

3 Press **▲** or **▼** until “SURROUND” is displayed in purple.

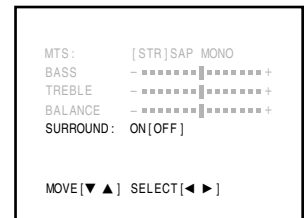

4 Press **◀** or **▶** to select “ON”.

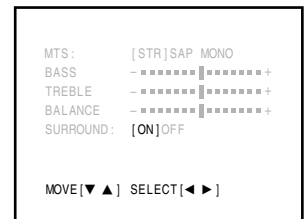

In general, you should leave your TV on SURROUND [ON] so it can automatically produce surround stereo or monaural sound, depending on the broadcast type.

Note: “MTS” function is not available while in the VIDEO mode.

To deactivate the surround effect

Select “OFF” in step 4 above.

Listening to second language

- 1 When the TV receives a SAP broadcast, the word “SAP” is displayed on the screen.

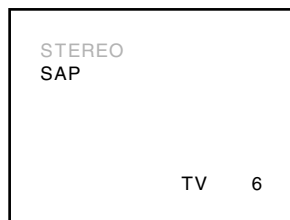

- 2 Press **MENU** until the Audio menu is displayed on the screen.

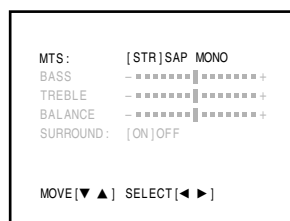

- 3 Press ▼ or ▲ until “MTS” is displayed in purple.
If a SAP broadcast is received, “SAP” will be displayed in yellow.

- 4 Press ◀ or ▶ until “SAP” is displayed in purple.
You will hear only the second language from the left and right speakers.

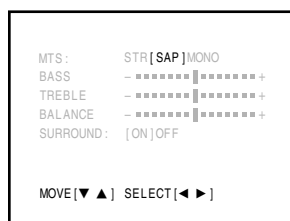

Watching Picture-in-Picture

In addition to the main picture, another TV program or video source being received through the VIDEO input jacks can be displayed simultaneously as a small picture. This is called PIP (Picture-in-Picture).

Be sure to connect a VCR with the VIDEO/AUDIO cables. See page 5 for details.

Note:

Signal source input through the *COLOR STREAM* terminals cannot be displayed as a small picture. Also, when the main picture source is in "COLOR STREAM", PIP is not available.

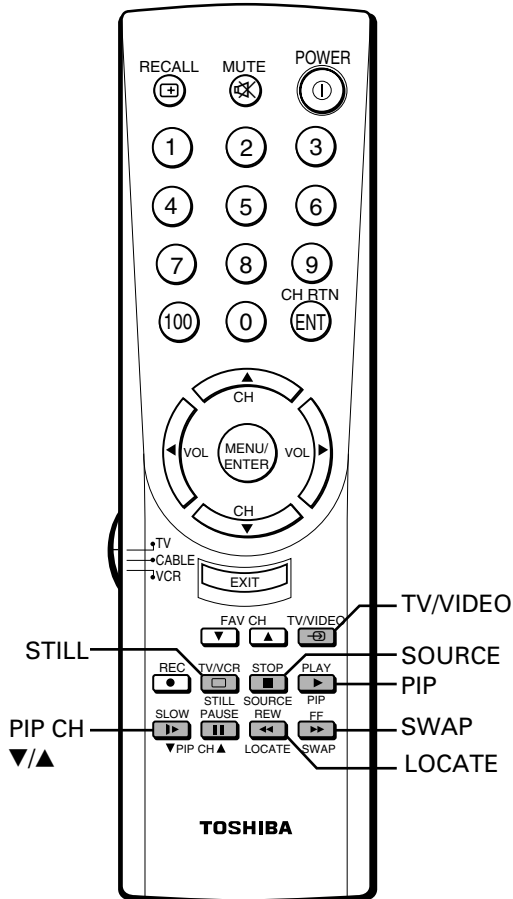

Displaying a small picture

- 1 Press **PIP** once to display a small picture. The 1/9 size window picture will appear. If you press **twice**: The 1/16 size window picture will appear.

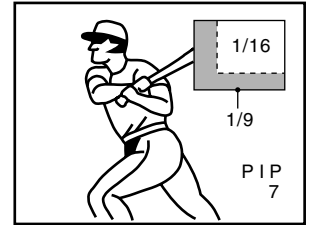

- 2 Press **SOURCE** to select the video input source ("VIDEO 1" or "VIDEO 2") for the small picture. The selected source will be displayed in purple.

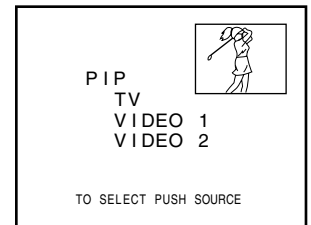

- 3 Select channels for the PIP using the VCR's channel keys.

Using the PIP CH ▼/▲ buttons

- 1 Press **TV/VIDEO** to select "VIDEO 1" or "VIDEO 2" (main picture source) and press **SOURCE** to select "TV" (PIP source)

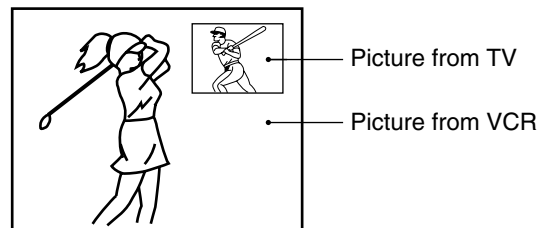

- 2 Press **PIP CH ▼** or **▲** to select channels for the small picture.

If the V-CHIP Control feature is active and you try to watch a TV program that exceeds the rating limits you set, the TV will enter into the program block mode. See page 30 for details.

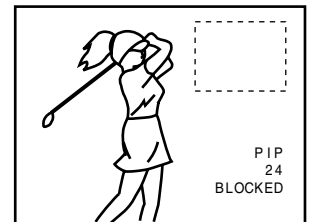

To turn off the small picture, press PIP

- **Twice**, if you watch the 1/9 size window picture.
- **Once**, if you watch the 1/16 size window picture.

Using advanced functions

To change the position of the small picture

Press **LOCATE** repeatedly when a small picture is displayed. The display position of the small picture will change in order.

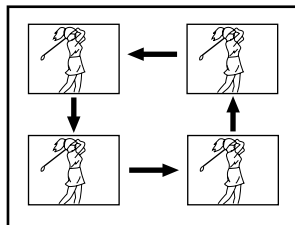

To switch the main and small picture

Press **SWAP** when a small picture is displayed.

The main and small pictures will switch.

To switch them again, press **SWAP** again.

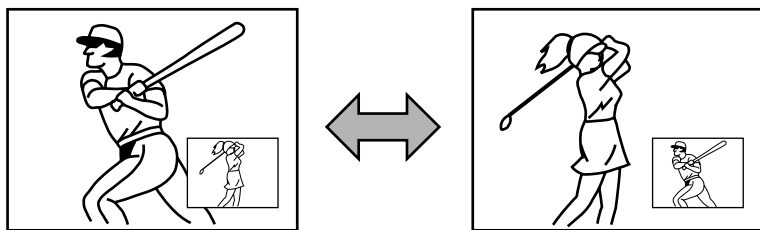

To freeze the small picture

Press **STILL** when a small picture is displayed.

The small picture will become a still picture.

To return to a moving picture, press **STILL** again.

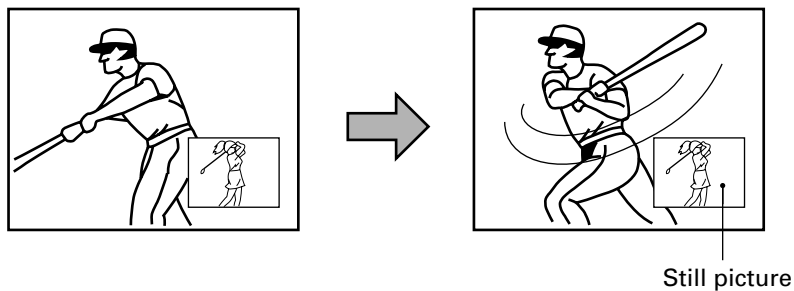

Programming Your Favorite Channels

The Favorite Channel Programming feature allows you to program up to 12 of your favorite channels. Once programmed, you can use the **FAV CH** ∇/\blacktriangle buttons on the Remote Control to scan through only your favorite channels, skipping other channels you do not normally view.

You can use the **CHANNEL** \blacktriangle/∇ buttons to scan through all the channels you have programmed into the TV's memory.

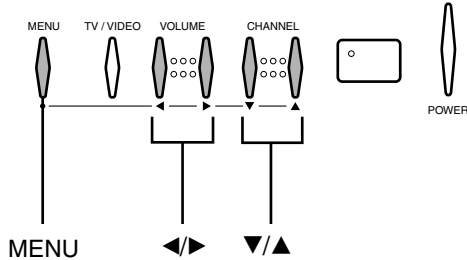

Programming your favorite channels

- 1 Select a channel you want to program.
(You must be on the channel you want to set or clear.)

Example: channel 2

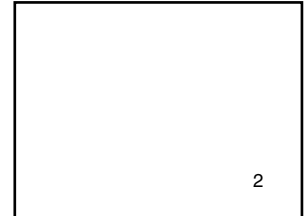

- 2 Press **MENU** until the Setup menu is displayed on the screen.
- 3 Press \blacktriangle or ∇ until "FAVORITE CH" is displayed in purple.

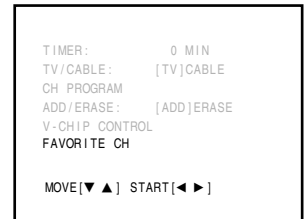

- 4 Press \blacktriangle or ∇ to display the FAVORITE CH program menu. Each time you press \blacktriangle or ∇ , you are guided between "SET" and "CLEAR".

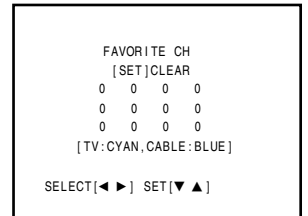

- 5 **To program channels:**
Select "SET". Then press \blacktriangle or ∇ until the channel number to be programmed ("2" in this example) replaces "0" on the display.

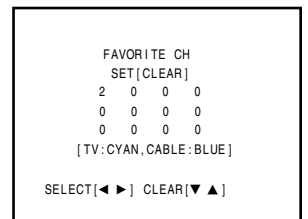

To erase channels:
Select "CLEAR". Then press \blacktriangle or ∇ until "0" replaces the channel number to be erased, "2" for example.

- 6 Repeat steps 1 to 5 for other channels.

Selecting your favorite channels

To select the favorite channels you have programmed, use the **FAV CH** ∇/\blacktriangle buttons on the Remote Control instead of using the **CHANNEL** \blacktriangle/∇ buttons.

Note: The **FAV CH** ∇/\blacktriangle buttons cannot function if you have not programmed your favorite channels.

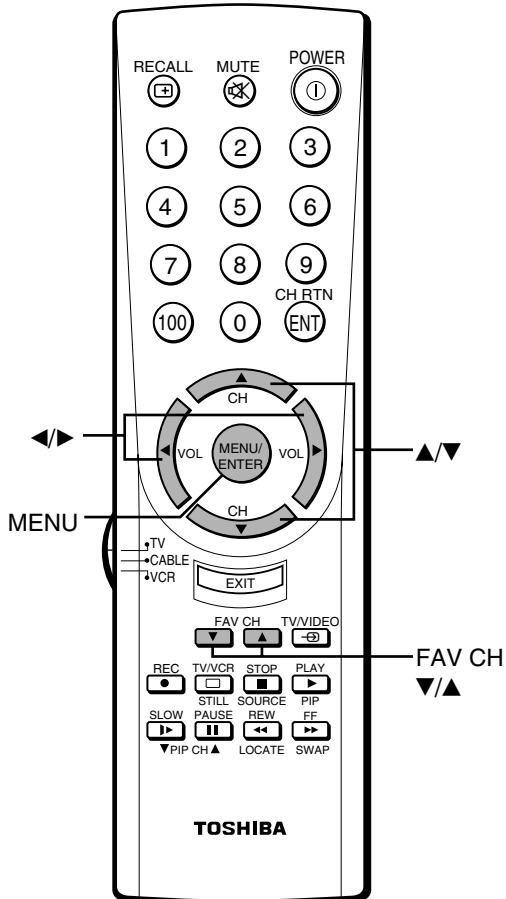

Operating Closed Caption Feature

You have two options with the closed caption feature: captions or text.

A caption is a printed version of the dialogue, narration and/or sound effect of a TV program. Text is information not related to the program that appears on the lower half of the screen.

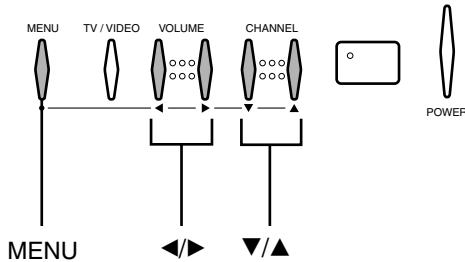

Viewing captions or text

- 1 Select the desired program.
The captioned programs are usually noted in your local TV listings by service marks such as “CC”.
- 2 Press **MENU** until the Option menu is displayed on the screen.
- 3 Press **▲** or **▼** until “C.CAPT” is displayed in purple.
- 4 Press **◀** or **▶** to select the closed caption mode.

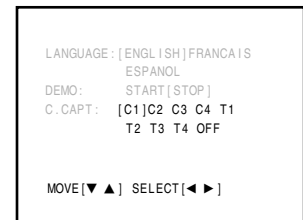
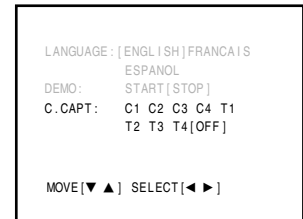

- Select C1, C2, C3, or C4 to view captions. Select C1 for translation of the primary language in your area.



- Select T1, T2, T3, or T4 to view Text.

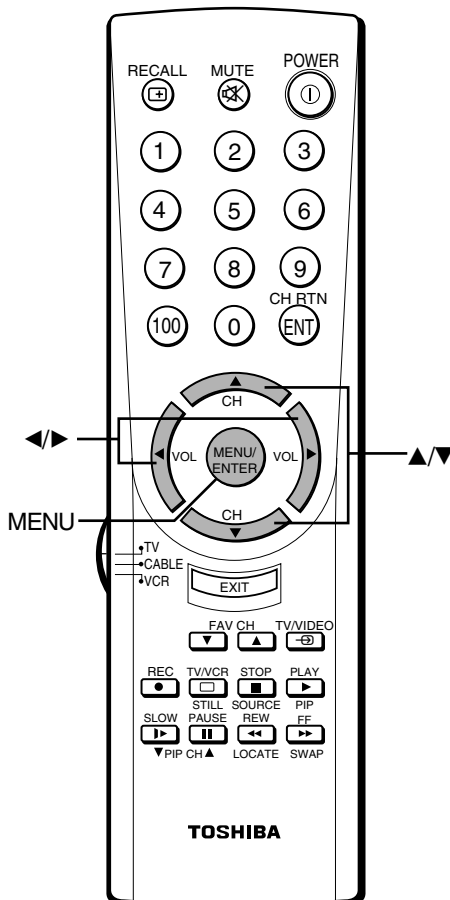
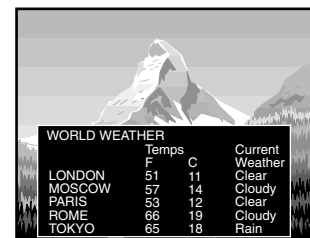

To turn off the closed-captioned feature

Select “OFF” in step 4 above.

Notes:

- A closed-captioned signal may not be decoded in the following situations.
 - When a video tape has been dubbed.
 - When the signal reception is weak.
 - When the signal reception is non-standard.
- If you select a closed-captioned channel and the Text mode, the text screen always appears.
However, text characters are not displayed when no signal is aired.

Using V-CHIP Control

Some TV programs and movies include signals that classify the content of the program (violence, sex, dialog, language). The V-CHIP Control feature in this TV detects the signals and blocks the programs according to your selections. To use this feature, perform the following setup.

Selecting the V-CHIP CONTROL menu

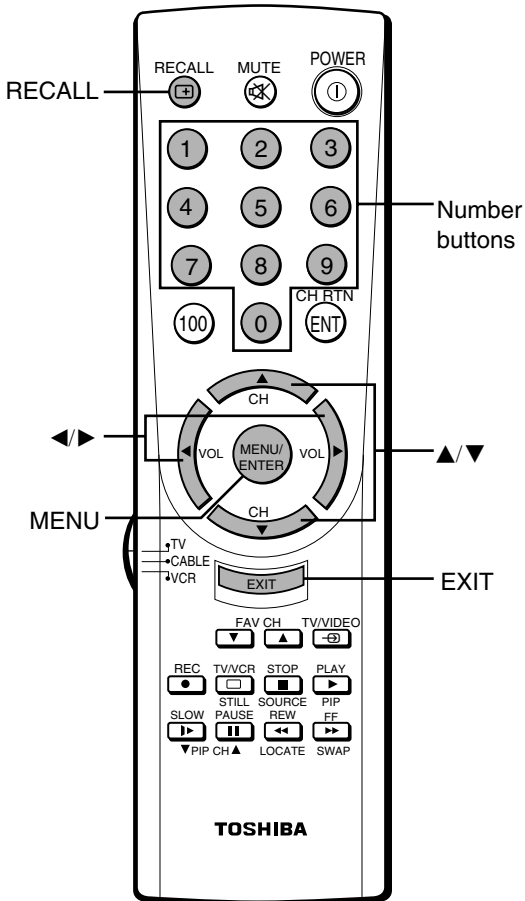

1 Press **MENU** then **▲** or **▼** repeatedly until “V-CHIP CONTROL” in the Set up menu is displayed in purple.

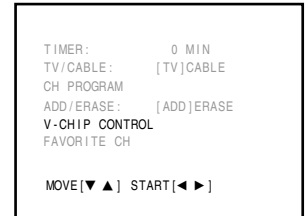

2 Press **◀** or **▶** to display the pin code entering mode.

- **Factory reset status**

Set your 4 digit code by pressing the **Number buttons** (0-9).

Example: To enter “1110”

Press 1, 1, 1, and 0 in order.

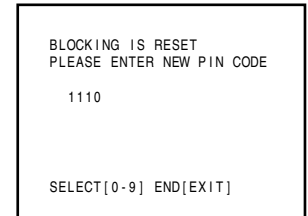

- **When the pin code is already stored**

Press the **Number buttons** (0-9) to enter the 4-digit pin code used to block channels.

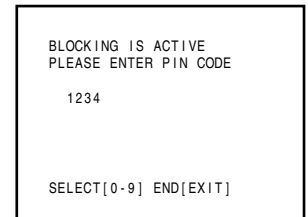

If a wrong pin code has been entered this message will appear. Try to enter the correct code again.

If you can not remember the pin code you have stored, while in the pin code entering mode, press the **RECALL** button four times within 5 seconds.

The pin code you have stored will be released. (Factory reset status).

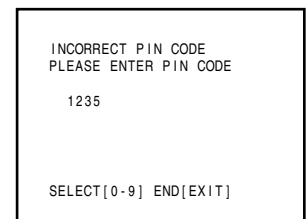

3 After about 1 second, the screen changes to the V-CHIP CONTROL menu as shown.

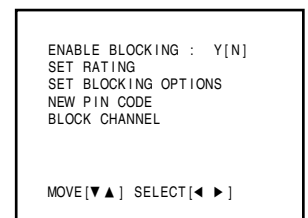

To return to the normal picture

Press **EXIT**.

Continue to set each item following the steps on the next page.

V-CHIP CONTROL menu

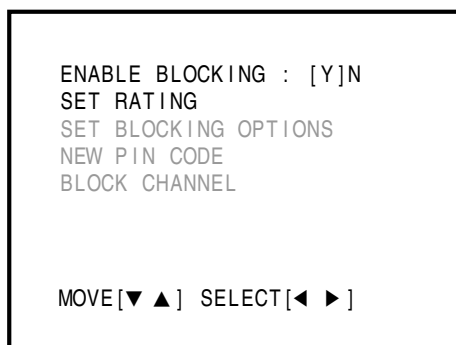

To select each item

Press ▼ or ▲.

Adjusting the V-CHIP CONTROL menu

ENABLE BLOCKING

Press ◀ or ▶ to select “Y” or “N”.

Y: To enable your setting (Block)

N: To release your setting (Unblock)

Note: The BLOCK CHANNEL function is not affected with this selection.

SET RATING (Setting the movie or TV ratings for your choice)

- 1 Press ◀ or ▶ to display the SET RATING menu.
- 2 Press ▼ (or ▲) to select item.
- 3 Press ▶ to block (display “X”)
 - Press ◀ to unblock (display “✓”)
- 4 Repeat steps 2 and 3 to set the next item.

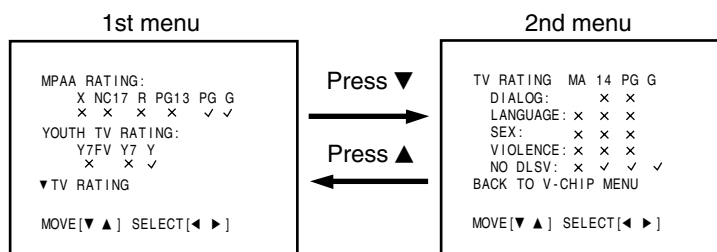

About Rating

MPAA RATING: Independent rating system for movies

G: General Audience (Appropriate for all ages)

PG: Parental Guidance Suggested (Some material may not be suitable for children)

PG13: Parents Strongly Cautioned (Some material may be inappropriate for children under 13)

R: Restricted (Under 17 requires accompanying parent or adult guardian.)

NC17: Not intended for anyone 17 and under

X: X-rated (For adults only)

TV RATING: Independent rating system for Broadcasters

Y: All Children (This program is designed to be appropriate for all children)

Y7, Y7FV: Directed to Older Children (This program is designed for children age 7 and above. Note: For those programs where fantasy violence may be more intense or more combative than other programs in this category, such programs will be designated TV-Y7-FV.)

G: General Audience (Most parents would find this program suitable for all ages.)

PG: Parental Guidance Suggested (This program contains material that parents may find unsuitable for younger children.)

D) Some suggestive dialog **L)** Infrequent coarse language

S) Some sexual situations **V)** Moderate violence

14: Parents Strongly Cautioned (This program contains some material that many parents would find unsuitable for children under 14 years of age.)

D) Intensely suggestive dialog **L)** Strong coarse language

S) Intense sexual situations **V)** Intense violence

MA: Mature Audience Only (This program is specifically designed to be viewed by adults and therefore may be unsuitable for children under 17.)

L) Crude or indecent language **S)** Explicit sexual activity

V) Graphic violence

The rating of the TV programs you are now watching can be confirmed by pressing the **RECALL** button.

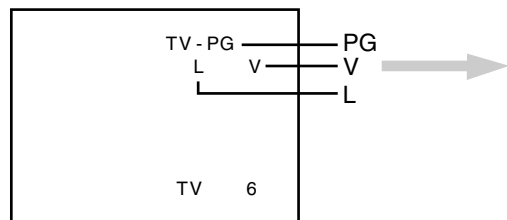

Using V-CHIP Control (continued)

V-CHIP CONTROL menu

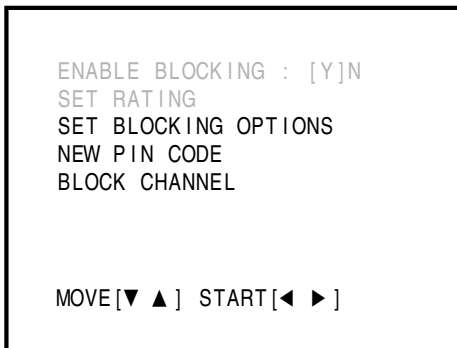

To select each item

Press ▼ or ▲.

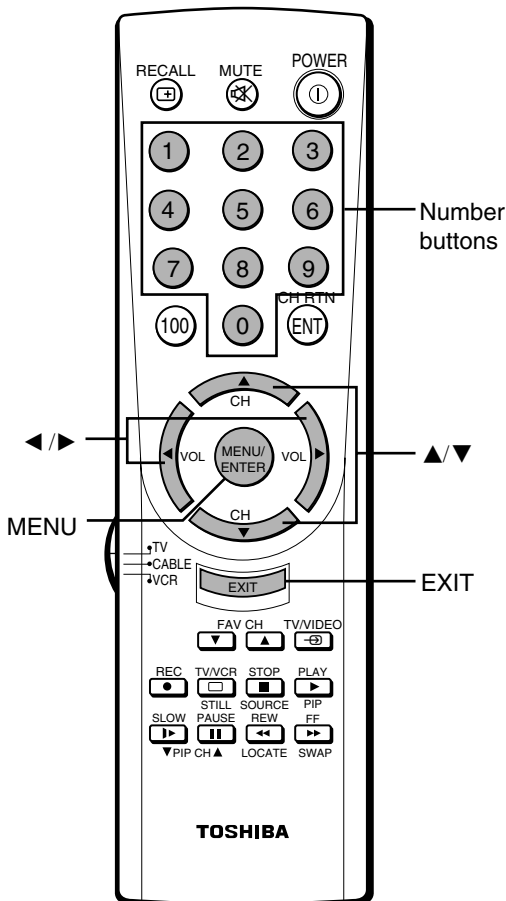

Adjusting the V-CHIP CONTROL menu (continued)

SET BLOCKING OPTIONS

Press ◀ or ▶ to display the SET BLOCKING OPTIONS menu, then press ▼ or ▲ to select item.

BLOCK MPAA UNRATED

Press ◀ or ▶ to select “Y”(Block) or “N”(Unblock) for unrated programs on MPAA rating system.

BLOCK TV NONE RATING

Press ◀ or ▶ to select “Y”(Block) or “N”(Unblock) for programs rated NONE on TV PARENTAL GUIDELINES.

If you select “Y”, the NOTICE shown below will be displayed since the emergency information may also be blocked.

Note: The Picture-in-Picture is not blocked even if “Y” is selected.

SET BLOCKING OPTION menu

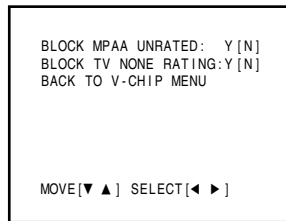

If you select “Y” on TV rating

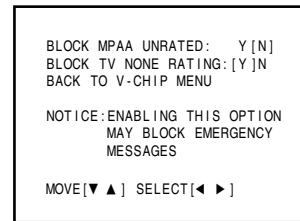

BACK TO V-CHIP MENU

Press ◀ or ▶ to return to the V-CHIP CONTROL menu.

NEW PIN CODE (Changing Pin Code)

1 Press ◀ or ▶ to display the NEW PIN CODE menu.

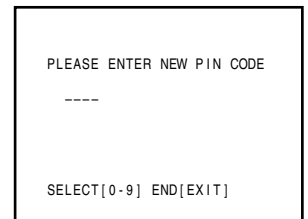

2 Press the **Number buttons** (0-9) to enter a 4-digit code.

The numbers you enter will replace the dashes in the display.

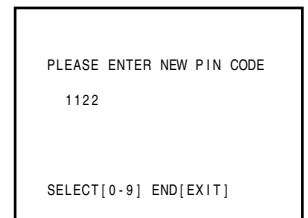

Example: To enter “1122”
Press 1, 1, 2, and 2 in order.

3 After about 1 second, the display will return to the V-CHIP CONTROL menu.

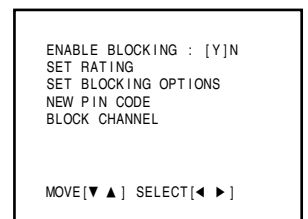

Unblocking programs temporarily

- 1 If you try to watch a TV program that exceeds the rating limits you set, the TV will enter into the program block mode.

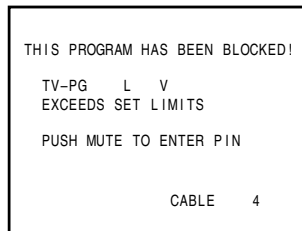

- 2 If you want to watch the blocked program temporarily, press **MUTE**.

Press the **Number buttons** (0-9) to enter the 4-digit code you have stored. If the number is correct, the block mode will be released. After 1 second, normal picture will appear.

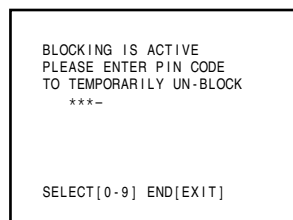

All blocking is disabled until the TV is turned off. It will be enabled when the power is reapplied.

If a wrong pin code is entered, this message appears. Enter the correct code again.

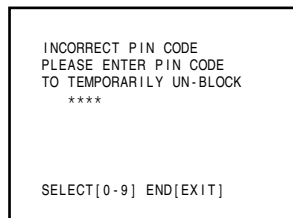

BLOCK CHANNEL function

With the CHANNEL BLOCK function, you can block specific channels. The TV will not be able to tune these channels with the **CHANNEL ▲/▼** buttons or **Channel Number** buttons, unless you clear the setting.

This TV has 8 memory spaces total, 4 for TV mode and 4 for CABLE mode.

To block channels

- 1 Select a channel you want to block.

- 2 Select “BLOCK CHANNEL” in the V-CHIP CONTROL menu by pressing ▼ or ▲.

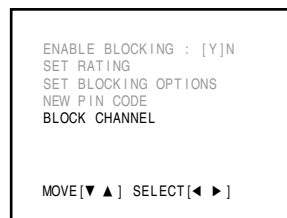

- 3 Press ◀ or ▶ to display the BLOCK CHANNEL menu.

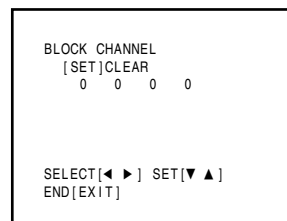

- 4 Press ◀ or ▶ to select “SET”, then press ▼ or ▲ until the channel number to be blocked (“2” in this example) replaces “0” on the display.

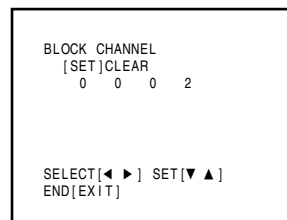

- 5 Repeat steps 1 to 4 for other channels.

- 6 Select another channel before turning off the TV.

To restore channels

- 1 Select “CLEAR” following the above steps 2 to 4.
- 2 Press ▼ or ▲ until “0” replaces the channel numbers.

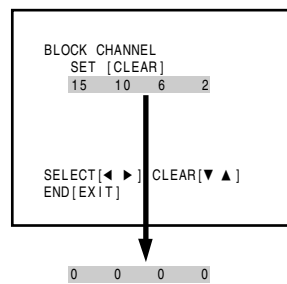

- 3 Press **EXIT** to erase the display.

Cleaning and Care

WARNING: TV sets use High Voltage. Do not try to remove the cabinet back. Refer servicing to qualified service personnel.

■ To clean the TV screen:

1. First remove the plug from the power outlet to avoid possible shock hazard.
2. Use a clean cellulose sponge or chamois cloth dampened with a solution of mild detergent and warm water to clean TV screen and trim. Do not use too much water on the TV screen. Water spills into the cabinet and may cause damage to the TV. Avoid excessive water.
3. Remove any extra moisture with the same cloth or a dry one.

■ To maintain the finish and appearance of the cabinet, polish it from time to time with a quality furniture polish.

Caution: *Never use strong solvents such as thinner, benzene or other chemicals on or near cabinet, as they might damage the finish of the cabinet.*

Specifications

Television system	NTSC standard
Channel coverage	VHF: 2 through 13 UHF: 14 through 69 Cable TV: mid band (A-8 through A-1, A through I) super band (J through W) hyper band (AA through ZZ, AAA, BBB) ultra band (65 through 94, 100 through 125)
Power source	120V AC, 60Hz
Power consumption	27A50: 90 W (average) 32A50: 100 W (average) 36A50: 100 W (average)
Audio power	5W + 5W
Speaker type	2-3/8 x 4-3/4 inches (60 x 120 mm)
Audio/Video terminals	S-VIDEO INPUT Y-INPUT: 1V (p-p), 75 ohm, negative sync. C-INPUT: 0.286V (p-p) (burst signal), 75 ohm AUDIO/VIDEO INPUT VIDEO: 1V(p-p), 75 ohm, negative sync. AUDIO: 150mV(rms) (30% modulation equivalent, 47k ohm) ColorStream™ (component video) INPUT Y: 1V (p-p), 75 ohm Cr: 0.7 V (p-p), 75 ohm Cb: 0.7 V (p-p), 75 ohm AUDIO/VIDEO OUTPUT VIDEO: 1V(p-p), 75 ohm, negative sync. AUDIO: 150mV(rms) (30% modulation equivalent, 4.7k ohm)
Dimensions	27A50: Width 25-5/8 inches (652mm) Height 23-7/8 inches (600mm) Depth 20-13/16 inches (526mm) 32A50: Width 30-5/8 inches (778mm) Height 27-5/16 inches (693mm) Depth 22-11/16 inches (575mm) 36A50: Width 34-9/16 inches (878mm) Height 30-1/2 inches (774mm) Depth 25-5/16 inches (642mm)
Mass	27A50: 75.0 lbs (33.6kg) 32A50: 121.7 lbs (55.2kg) 36A50: 158.0 lbs (71.6kg)
Supplied accessories	Remote Control with 2 size “AA” batteries
Optional TV stand	27A50: — 32A50: ST3230 36A50: ST3615, ST3640

Design and specifications are subject to change without notice.

Before Calling Service Personnel

Before calling service personnel, please check the following chart for a possible cause of the problem you are experiencing. A minor adjustment on your part may eliminate the problem and restore your TV reception.

Problem	Checks and Adjustments	Page
TV will not turn on	<ul style="list-style-type: none"> • Make sure the power cord is plugged in, then press POWER button. • Check battery in the Remote. (Maybe batteries are “dead”.) 	15 8
No picture, no sound	<ul style="list-style-type: none"> • Check antenna/cable connections. 	5
No sound, picture OK	<ul style="list-style-type: none"> • Maybe sound is muted. Try pressing VOLUME ► button. • Try another channel. (Maybe station trouble.) 	15
Poor sound, picture OK	<ul style="list-style-type: none"> • Try another channel. (Maybe station trouble or local interference from appliance.) 	
Poor picture, sound OK	<ul style="list-style-type: none"> • Check antenna/cable connections. • Try another channel. (Maybe station trouble or local interference.) • Adjust Picture menu. 	20
Poor reception of broadcast channels	<ul style="list-style-type: none"> • Try another channel. • Check antenna connections. • If using VCR, check TV/VCR button. 	5 10
No UHF, VHF OK	<ul style="list-style-type: none"> • Make sure TV/CABLE function is in “TV” mode. 	16
Black box appears on the screen	<ul style="list-style-type: none"> • Text may be turned on 	29
Cannot select a certain channel	<ul style="list-style-type: none"> • That channel may be locked out with BLOCK CHANNEL function, or erased with the ADD/ERASE function. 	33 17
Multiple images (ghosts)	<ul style="list-style-type: none"> • Try another channel. (Maybe station trouble.) • Use a highly directional outdoor antenna. 	
Poor color or no color	<ul style="list-style-type: none"> • Try another channel. (Maybe station trouble or local interference.) • Adjust TINT and/or COLOR in the Picture menu. • If you change the direction of the TV while the TV is activated, the picture may suffer from color shading. If so, turn off the TV and allow it to cool for about 30 minutes, then turn on the TV again. The picture should improve. 	20
No stereo or SAP sound from an MTS broadcast	<ul style="list-style-type: none"> • Check if MTS function is properly set. 	24
The Remote Control does not operate	<ul style="list-style-type: none"> • Check if TV/CABLE/VCR switch is properly set. • Maybe something was between the Remote and the remote sensor. • Maybe batteries are dead. Try replacing batteries with new ones. 	9, 10 8

Limited United States Warranty

Toshiba America Consumer Products, Inc. ("TACP") and Toshiba Hawaii Inc. ("THI") make the following limited warranties. These limited warranties extend to the original consumer purchaser or any person receiving this set as a gift from the original consumer purchaser and to no other purchaser or transferee.

Limited One (1) Year Warranty

TACP and THI warrant this product and its parts against defects in materials or workmanship for a period of one (1) year after the date of original retail purchase. During this period, TACP and THI will repair or replace a defective part, at their option, with a new or refurbished part, without charge to you. TACP/THI Authorized Service Station personnel will come to your home when warranty service is required. Depending on the type of repair required, the service will either be performed in your home or the set will be taken to the TACP/THI Authorized Service Station for repair and returned to your home at no cost to you.

Limited Two (2) Year Warranty of Picture Tube

TACP and THI further warrant the picture tube in this product against defects in materials or workmanship for a period of two (2) years after the date of original retail purchase. During this period, TACP and THI will repair or replace a defective picture tube, at their option, with a new or refurbished picture tube without charge to you, except that if a defective picture tube is replaced after one (1) year from the date of the original retail purchase, you pay labor charges involved in the replacement.

Rental Units

The warranty for rental units begins with the first rental or thirty (30) days from the date of shipment to the rental firm, whichever comes first.

Commercial Units

Products sold and used for commercial use have a limited ninety (90) day warranty for all parts, labor and picture tube.

Owner's Manual and Demographic Card

You should read this owner's manual thoroughly before operating this product. You should complete and mail the enclosed Demographic card within ten days after you, or the person who has given you this product as a gift, purchased this product. This is one way to enable TACP/THI to provide you with better customer service and improved products. Failure to return the Demographic card will not affect your rights under this warranty.

Your Responsibility

The above warranties are subject to the following conditions:

- (1) You must retain your bill of sale or provide other proof of purchase.
- (2) All warranty servicing of this product must be made by an Authorized TACP/THI Service Station.
- (3) **These warranties are effective only if the product is purchased and operated in the U.S.A. or Puerto Rico.**
- (4) Labor service charges for set installation, set up, adjustment of customer controls and installation or repair of antenna systems are not covered by this warranty. Reception problems caused by inadequate antenna systems are your responsibility.
- (5) Warranties extend only to defects in materials or workmanship as limited above and do not extend to any product or parts which have been lost or discarded by you or to damage to products or parts caused by misuse, accident, damage caused by Acts of God, such as lightning or fluctuations in electric power, improper installation, improper maintenance or use in violation of instructions furnished by us; or to units which have been modified or had the serial number removed, altered, defaced or rendered illegible.

How to Obtain Warranty Service

If after following all of the operating instructions in this manual and checking the section "BEFORE CALLING SERVICE PERSONNEL", you find that service is needed;

- (1) Call the TACP toll free number **1-800-631-3811** after you find a defective product or part to find the nearest TOSHIBA Authorized Service Station.
- (2) Please present your bill of sale or other proof to the Authorized Service Station.
"TACP/THI Authorized Service Station personnel will come to your home when warranty service is required. Depending on the type of repair required, the service will either be performed in your home or the set will be taken to the TACP/THI Authorized Service Station for repair and returned to your home at no cost to you."

In the Continental United States contact:



In Hawaii contact:
Toshiba Hawaii, Inc. 327 Kamakee Street, Honolulu, Hawaii
96814 (808) 591-8377

Ⓐ

All warranties implied by state law, including the implied warranties of merchantability and fitness for a particular purpose, are expressly limited to the duration of the limited warranties set forth above. With the exception of any warranties implied by state law as hereby limited, the foregoing warranty is exclusive and in lieu of all other warranties, guarantees, agreements and similar obligations of manufacturer or seller with respect to the repair or replacement of any parts. In no event shall TACP or THI be liable for consequential or incidental damages.

No person, agent, distributor, dealer or company is authorized to change, modify or extend the terms of these warranties in any manner whatsoever. The time within which action must be commenced to enforce any obligation of TACP or THI arising under this warranty or under any statute, or law of the United States or any state thereof, is hereby limited to 90 days from the date you discover or should have discovered, the defect. This limitation does not apply to implied warranties arising under state law.

This warranty gives you specific legal rights and you may also have other rights which may vary from state to state. Some states do not allow limitation on how long an implied warranty lasts, when an action may be brought, or the exclusion or limitation of incidental or consequential damages, so the above provisions may not apply to you.



ATTENTION CANADIAN CONSUMERS:

Canadian consumers are requested to complete the special Canadian "Warranty Registration Form" enclosed, and forward this completed form with a copy of bill of sale to TOSHIBA OF CANADA to "Register and Validate" their warranty.

Products purchased in the U.S.A. and used in Canada are not covered by these warranties.

Products purchased in Canada and used in the U.S.A. are not covered by these warranties.

Rev. 09-01-98

TOSHIBA AMERICA CONSUMER PRODUCTS, INC.

HEAD OFFICE/82 TOTOWA ROAD, WAYNE, NEW JERSEY 07470
FACTORY SERVICE CENTER/ 1420B TOSHIBA DRIVE, LEBANON, TENNESSEE 37087

TOSHIBA HAWAII, INC.

HEAD OFFICE/327 KAMAKEE STREET, HONOLULU, HAWAII 96814, U.S.A.

TOSHIBA OF CANADA LTD.

HEAD OFFICE/191 McNABB STREET, MARKHAM, ONTARIO, L3R 8H2, CANADA TEL: (905) 470-5400
SERVICE CENTERS/TORONTO: 191 McNABB STREET, MARKHAM, ONTARIO, L3R 8H2, CANADA TEL: (905) 470-5400
MONTREAL: 1643, NORTH SERVICE RD., TRANS-CANADA HIGHWAY, DORVAL QUEBEC, H9P 1J1, CANADA
TEL: (514) 856-4100
VANCOUVER: 22171 FRASER WOOD WAY, RICHMOND, B.C., V6W 1J5 TEL: (604) 303-2500

MANUFACTURED BY

TOSHIBA AMERICA CONSUMER PRODUCTS, INC.

PRINTED IN USA
(00-04)

TOSHIBA

23563890A